



SUPERIOR QUALITY, MADE IN THE USA

Built for the journey – Rooted in Quality – Dedicated to Care – Backed by Graham-Field



For over 40 years, Basic American by Graham-Field has been a trusted name in the extended care market, proudly designing and manufacturing high-quality beds right here in the United States. Our facility in Fond du Lac, Wisconsin stands as a testament to American craftsmanship—where skilled hands and a [commitment to excellence](#) come together to build products that support dignity and care.

Our AmeriLux, Zenith, Matrix, Regency HD, and Liberty bed models showcase innovation [powered by American ingenuity](#). Engineered with industry-leading technology and thoughtfully crafted for durability, comfort, and value, these feature-rich beds deliver exceptional performance for every budget.

When you choose Basic American, you're not only choosing quality—you're [supporting American workers](#) and time-honored manufacturing traditions.





We proudly make all of our beds in the USA to the highest safety standards:*

- FDA Recognized Standard: ANSI/AAMI STD ES60601-1
- Health Canada Recognized Standard: CAN/CSA C22.2 No. 60601-1 (IEC 60601-1:2012-Edition 3.1)
- Includes International Standards: IEC 60601-1, IEC 60601-1-2, IEC 60601-2-52

* Zenith, Matrix, Regency models

Our Extended Care Beds Feature/Have:

- Certified transport devices - passes threshold clearance at ALL heights
Ideal for evacuation³
- Silver Solutions™⁸ powder-coating provides antimicrobial surface protection and deters the growth of odor-causing bacteria
- Sealed ball-bearing joints provide continuous, maintenance-free, silent operation⁴
- No holes on top surface of tubes that could harbor fluids/bacteria
- Grounded frame with right-angle hospital grade plug for safety
- Adjustable wall-saver protects the wall with smallest footprint
- Mattress retainers that are adjustable for multiple mattress lengths
- Two-Pedal locking system as an available option on select beds
- Patented Hi-Lo mechanism adds life to the motors
- Sturdy, no-sag, grid sleep surface with cross braces
- 360 mobility for cleaning



Intuitive Two-Pedal Locking System

- Centrally positioned and easily visible from a distance ensures the caregiver that bed is locked at a glance
- Bed rolls at any height increasing caregiver safety
- Readily accessible at ALL bed widths and heights (even lowest)
- Select option at time of purchase*
*On select models



Slide-W-I-D-E®
Models Only

Mattress Retainers⁹

- Adjustable for multiple mattress lengths
- Standard on all beds

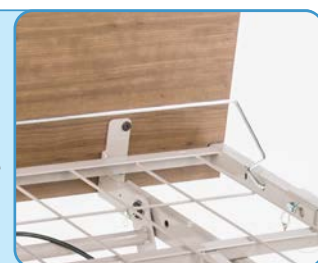

Adjustable Wall-Saver

- Maximum wall protection
- Adjustable clearance lengths
- Standard on all beds

AmeriLux™

by graham field

AmeriLux Series Standard Features:

- Adjustable height from ultra-low at 4 inches to nursing height at 30 inches
- Bed electronics feature full floor clearance, preventing floor contact vs similar models offered by competitors
- 36 inch width or 42 inch width fixed deck
- Advanced Positioning System (APS) includes One-Button Comfort/Cardiac Chair Position
- Sleek, black frame

AmeriLux Available Options:

- Customizable design options (boards and wooden side boards)
- Embedded staff control in footboard (allows Trendelenburg/Reverse Trendelenburg)



AmeriLux SERIES

SHOWN WITH APS

Raised Head Position



AmeriLux SERIES

SHOWN WITH APS

Supine Position





Zenith 9200 SERIES

9200 WITH APS SHOWN WITH
Slide-W-I-D-E® deck option
Supine Position

Zenith

Zenith Series Standard Features:

- Straight-Line Hi-Lo Travel with Patent-Awarded Design Technology
- Mounted Head and Footboards create a built-in push bar and reduces breakage*
*Applies to g200 only



Zenith 7200 SERIES

7200 & 7200 WITH APS SHOWN WITH
optional staff control
Supine Position

Slide-W-I-D-E®

EXPANDABLE/RETRACTABLE SLEEP DECK

OPTIONAL ON Zenith 9200/7200
STANDARD ON Regency HD

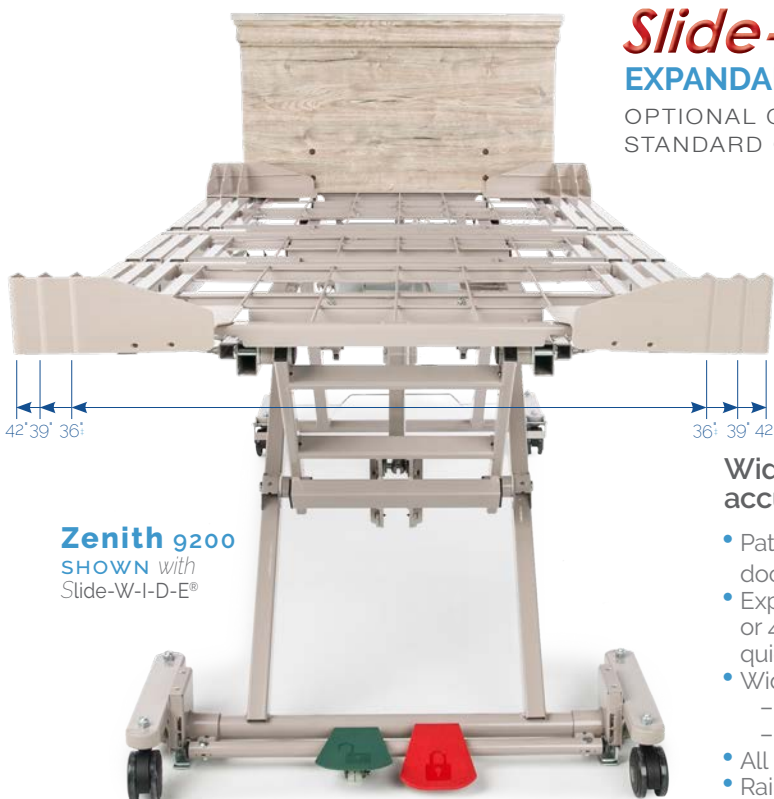

Zenith 9200
SHOWN with
Slide-W-I-D-E®



Quick-release
ball-detent pins
attached to beds
with lanyards

Wider sleep surfaces may help reduce falls by residents accustomed to sleeping on common consumer products.⁷

- Patented design allows for quick adjustment, ideal for moving through doorways to assist in emergency evacuations
- Expandable/retractable deck quickly and easily adjusts to 36", 39", or 42 inches (Zenith series) or 39", 42 or 48 inches (Regency HD) with two quick-release ball-detent pins on each side
- Wider head and footboards available:
 - 42 inch width (Zenith series)
 - 48 inch width (Regency HD series)
- All pins are attached to the bed with lanyards, eliminating lost parts
- Rails and assist devices are quick-release without tools



Matrix

Matrix Series Standard Features:

- Advanced Positioning System (APS) includes One-Button Comfort/Cardiac Chair Position
- Straight-Line Hi-Lo Travel with Patent-Awarded Design Technology

Matrix 6200 SERIES

6200 WITH APS shown with intuitive pedal-lock option & optional staff control Raised Head Position



GENDRON[®] by graham-field

REGENCY HD 800 BARIATRIC SERIES

Regency Bed Available With:

- Advanced Positioning System (APS) includes One-Button Comfort/Cardiac Chair Position
- 4-inch total-lock casters (as shown)

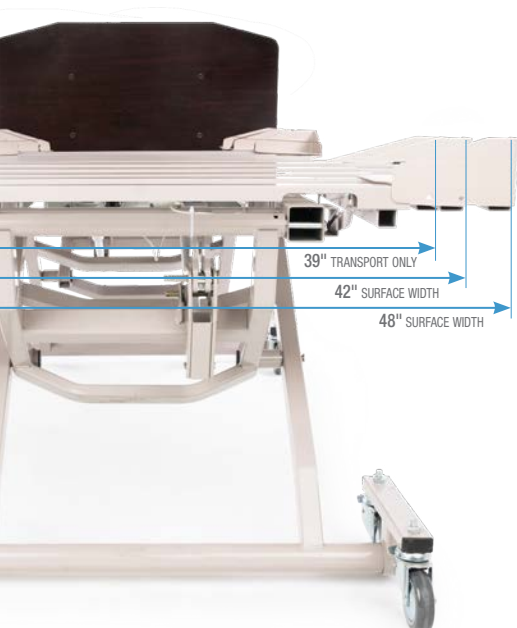

Regency HD Series
SHOWN WITH APS
Chair Position





Advanced positioning allows the bed to go into numerous positions

- Positively influencing clinically driven outcomes through multiple positioning options
- Accommodating post-surgical rehab positioning to facilitate resident comfort
- May reduce caregiver strain and potential injuries
- Built-In Hi-Lo Lockout Feature (on APS Hand Controls)*
*Excludes AmeriLux
- Available on AmeriLux, Zenith, Matrix, and Regency HD

Reverse Trendelenburg



Trendelenburg



Zenith 9200 APS SHOWN

with Advanced Positioning System, Slide-W-I-D-E® deck option, and intuitive pedal-lock option
Comfort/Cardiac Chair Position

LIBERTY SERIES

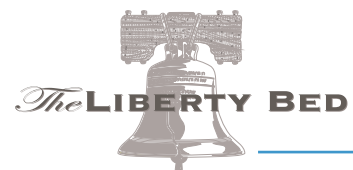

Liberty Bed Standard Features:

- Desired features at affordable price point
- Four locking casters

Liberty Bed Available With:

- Optional one-step red/green pedal lock to maximize your security (as shown)
- Optional 4-inch total-lock casters increase under-bed clearance

Liberty SHOWN

with intuitive pedal-lock option
Supine Position

Counter-Rotating Assist Device

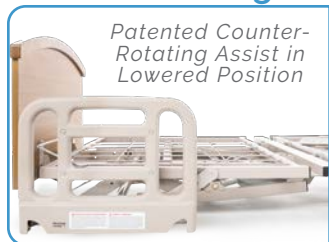

- Meets FDA Entrapment Guidelines
- Removable without tools
- Moves out of the way for lateral transfers
- Pivots away from egress area

Fixed Assist Devices

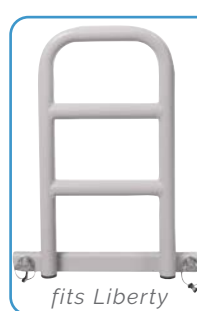

- Moves out of the way for lateral transfers
- Tool-free assembly and removal

Pivot Assist Bar



USB Power Supply



- Charges most devices

Under-Bed Light

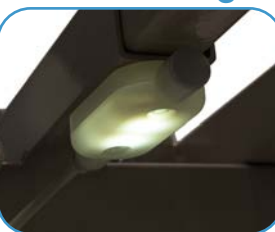

- Helps reduce fall risks
- Eliminates bright light intrusion
- Multi-level light intensity

Trapeze and Adapter



- Pivots out of the way when not in use
- Compatible with all Zenith and Matrix models
- Rigid design

Embedded Staff Control

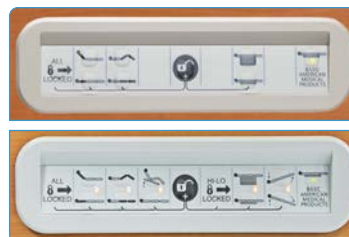

- Standard functionality and lockouts, or Advanced Positioning System (APS)
- Angled-Up display for improved visibility
- Two-Stage lockouts deter unwanted changes

Universal Bed Cart



- Designed for one-person mounting and maneuverability
- Allows beds to fit through narrow doorways
- Adjustable to accommodate multiple frame widths

APS Pendant

Standard Pendant



Board Mounted IV Socket



- Mounts with 2 screws
- Easy to install
- IV pole sold separately
- Compatible with all Basic American models²

Pin-On Wide Kit

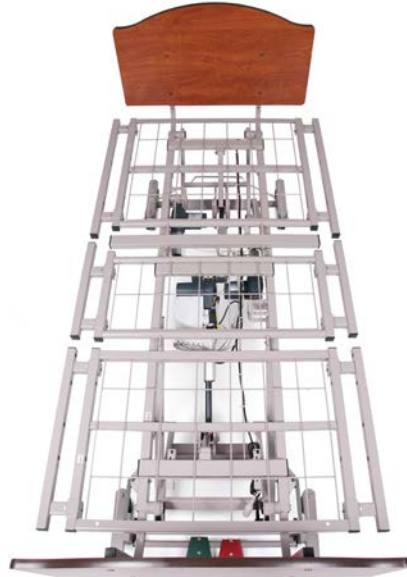

- Compatible with all 36" wide Zenith and Matrix models
- Available in 39" or 42" width kits

Edema Foot Ratchet Kit



- Elevated foot rest
- Standard on Zenith g200
- Optional on Matrix 6200 and Zenith 7200

Surface Length Extension Kit

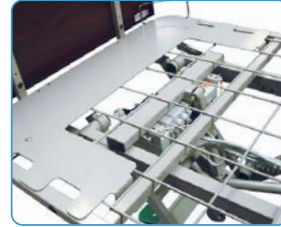

- Extends standard length bed frame from 84" to 88". Complete with solid pan extension, mattress retainer, and installation hardware
- Compatible with Zenith models²
- Easy to install

AMERILUX & REGENCY HD ACCESSORIES

AmeriLux

Fall Mat



USB Power Supply



Under-Bed Light

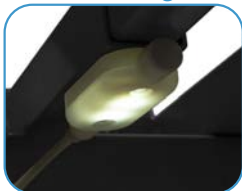

Counter-Rotating Assist Device



Fixed Assist Device



Regency HD

Half Trapeze*



*Full Length Trapeze Available

USB Power Supply



Under-Bed Light

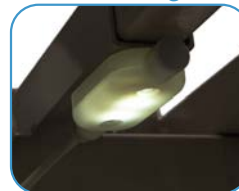

Counter-Rotating Assist Device



Fixed Assist Device





Center Crown
(available as 3DL or Laminate)



Crescent
(available as 3DL or Laminate)



Rectangle
(available as 3DL or Laminate)



Drop Edge
(available as Laminate only)



Mission
(available as 3DL or Laminate)



Suwanee
(available as 3DL only)



Raised Panel
(available as 3DL or Laminate)



Crescent with Cap
(available as 3DL only)



Straight Wood Cap
(available as Laminate only)



DESIGN THAT FRAMES THE ROOM



Raised Panel Boards
(Aria & Talas Cherry)



3 DL FINISH OPTIONS

SMOOTH SURFACE



Kensington Maple



Solar Oak



Windsor Mahogany



Shaker Cherry



Wild Cherry



Cocoa Pecan



Cocobala



Talas Cherry



Arctic Groovz



Fonthill Pear

TEXTURED SURFACE



Aria



Honey-Comb

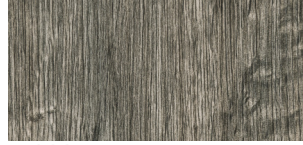

Pebble



Dark Bay



Moon Dust

Discover additional, exclusive finish options that may be available upon request.

LAMINATE FINISH OPTIONS

SMOOTH SURFACE



Kensington Maple



Cocobala



Wild Cherry



Solar Oak



Windsor Mahogany



Shaker Cherry



Aria



Talas Cherry

Bed Specifications:

	AmeriLux	Zenith 9200	Zenith 7200	Matrix 6200	Regency HD	Liberty
Adjustable Patient Surface Length:	80 - 84 inch	80 - 84 inch	80 - 84 inch	80 - 84 inch	80 - 84 - 88 inch	76 - 80 inch
Fixed Sleep Deck Width:	36 [†] or 42 inch	36 [†] inch	36 [†] inch	36 [†] or 42 inch	42 or 48 inch	36 [†] inch
Slide-W-I-D-E™ Option Sleep Deck Width:	—	36 [†] or 39 or 42 inch	36 [†] or 39 or 42 inch	—	39 [★] or 42 or 48 inch	—
Height Travel Range:	4 [‡] 30 inch	7 - 30 inch	7.95 - 30 inch	8.95 - 27 inch	9 - 30 inch	9.95 - 24.4 inch
Safe Working Load: ¹ <i>includes resident, support surface, head/footboards, & accessories</i>	550 lb	600 lb	550 lb	450 lb	800 lb	450 lb
Maximum Resident Weight: <i>EVENLY DISTRIBUTED - refer to user manual</i>	500 lb	550 lb	500 lb	400 lb	700 lb	400 lb
Actuators:	4 DC	4 DC	4 DC	4 DC	4 DC	3 DC

Options & Features:

Advanced Positioning Pendant:	■	■	■	■	■	—
Pendant Connects to Either Side of Bed:	■	■	■	■	■	—
Trendelenburg/Reverse Trendelenburg: <i>via APS staff control</i>	■	■	■	■	■	—
Slide-W-I-D-E® Option Available:	—	■	■	—	■	—
Patented Super-Efficient Transmission: <i>Improved speed and less strain on the motor</i>	■	■	—	—	■	—
Hi-Low Actuators Unloaded in Low Position:	■	■	■	■	■	—
Embedded Staff Control: ²	■	■	■	■	■	—
Splash Proof Electronics:	■	■	■	■	■	■
Intuitive Pedal Lock:	—	■	■	■	—	■ ²
Locking Casters	■	■	■	■	■	■
Bed Locks and Rolls at Any Height: <i>reducing care-giver back strain</i>	■	■	■	■	■	■
Silent Operating, Sealed Ball-Bearings: <i>Maintenance-Free</i>	■	■	■	■	■	—
Taller Casters: <i>approximately 7 inches of clearance</i>	—	—	—	—	—	■
Maximum Clearance: <i>overbed tables and lifts</i>	■	■	■	■	■	5.1 inch [†]
Can be Used as Resident Transport Devices:	—	■	■	■	■	■
FDA Guideline Compliance: <i>for Bed Entrapment Risk Reduction⁵</i>	■	■	■	■	■	—
Silver Solutions Powder Coating: <i>process provides antimicrobial surface protection⁸</i>	■	■	■	■	■	■
Made in the USA by Skilled Craftsmen: <i>built to withstand trouble-free use for many years</i>	■	■	■	■	■	■

Accessories:

Edema Foot Ratchet: ² <i>(elevates the foot end of the bed)</i>	■	■	■	■	■	■
Plastic Pan Deck: ²	—	■	■	■	—	—
Backup Battery: ² <i>(external or mounted onboard)</i>	■	■	■	■	■	—
Length Extension Kit: ² <i>(converts from 84 to 88 inch length)</i>	—	■	■	—	—	—
42-inch Pin-on Wide Kit: ²	—	■	■	■	—	—

Warranty:

Main Frame & Welds	12 years	15 years	15 years	15 years	10 years	10 years
Control Box & Actuator Motors	5 years	5 years	5 years	4 years	5 years	2 years
Hand Control Pendant & Cabling	3 years	3 years	3 years	3 years	3 years	1 year
Staff Control & Cabling	3 years	3 years	3 years	3 years	3 years	—

■ Standard ■ Available ■ Optional — Not Applicable/Available

★retracts to 39 inches for mobility only

† fixed base

‡ ± 1 inch tolerance

¹maximum weight capacity - evenly distributed

²anytime add-on or with purchase

³excluding AmeriLux

⁴excluding Liberty

⁵"Hospital Bed System Dimensional and Assessment Guidance to Reduce Entrapment" details at www.fda.gov

⁷Fragala G, Perry B, Fragala M, Examining bed width as a contributor to risk of falls from bed in long term care. *Annals of Long-Term Care: Clinical Care and Aging*, 2012; 20(6):35-38

⁸GF Health Products, Inc. makes no independent representations or empirical statements about Silver Solutions. This information is reprinted from: TCI Powder Coatings, EPA Guidance for EPA Registration 40 CFR 152.25

⁹wireframe retainers are standard on all beds except Slide-W-I-D-E® models which use plastic corner retainers

GF Health Products, Inc. is an
ISO 13485:2016 / MDSAP Certified Company

Color variations may occur due to monitor or printer settings.

+1 678-291-3200

Information contained herein is subject to change without notice.
The most current and complete product information can be found on our website.

www.grahamfield.com



© 2017, GF Health Products, Inc. All Rights Reserved.
Basic American Medical Products and Gendron are a registered trademark
of GF Health Products, Inc.

grahamfield

GF1700011RevL26