



574G SERIES 3-POSITION RECLINER ASSEMBLY AND OPERATING MANUAL

SAVE THIS MANUAL FOR FUTURE USE.

CONTENTS

INTRODUCTION	3
INTENDED USE	3
IMPORTANT SAFETY PRECAUTIONS – READ BEFORE USE	3
WARNINGS.....	3
FEATURES	5
ASSEMBLY	6
UNPACKING INSTRUCTIONS	6
ASSEMBLY INSTRUCTIONS	6
BACK TO FRAME ASSEMBLY	6
UPHOLSTERED LEGREST ASSEMBLY.....	6
FRONT CASTER TO FRAME ASSEMBLY.....	7
REAR CASTER TO FRAME ASSEMBLY	7
OPERATION	8
CASTER OPERATION	8
TO OPERATE REAR SWIVEL LOCKING CASTERS.....	8
RECLINER OPERATION.....	8
RECLINING BY USER.....	9
RECLINING BY CAREGIVER.....	9
RECLINER POSITION STABILIZATION	9
ARTICULATING HEADREST	10
MOLDED TABLE.....	10
OPERATION.....	10
STORAGE	10
CARE AND MAINTENANCE.....	11
EVERY THREE MONTHS	11
UPHOLSTERY MAINTENANCE AND STAIN REMOVAL.....	11
CDC RECOMMENDATIONS	11
DISPOSAL AND KEY TO SYMBOLS	13
DISPOSAL.....	13
KEY TO SYMBOLS.....	13
TECHNICAL SPECIFICATIONS.....	13
LIMITED WARRANTY	14
INDEX	15

INTRODUCTION

This manual contains assembly, operation, and maintenance instructions for the Lumex 3-Position Recliner Series 574G. Read the entire manual carefully before using the recliner, and refer to it during use if you have questions. If you have further questions, call GF / Lumex Technical Support at 1.770.368.4700.

INTENDED USE

The Lumex 3-Position Recliner is intended to make the care, treatment and recovery of patients easier and more comfortable by helping to ease discomfort from circulatory, respiratory, and other ailments.

Lumex Series 574G supports patient weight up to 250 lb (113.4 kg), EVENLY DISTRIBUTED.

IMPORTANT SAFETY PRECAUTIONS — READ BEFORE USE

The safety statements presented in this chapter refer to the basic safety information that the 574G user shall pay attention to and abide by. There are additional safety statements in other chapters or sections, which may be the same as or similar to the following, or specific to the operations. Note the following special statements, used throughout this manual, and their significance:

- ⚠ WARNING: Indicates a potential hazard situation or unsafe practice that, if not avoided, could result in death or serious personal injury.**
- ⚠ CAUTION: Indicates a potential hazard or unsafe practice that, if not avoided, could result in minor or moderate personal injury.**
- ▲ NOTICE: Indicates a potential hazard or unsafe practice that, if not avoided, could result in product or property damage.**

Info: Provides application recommendations or other useful information to ensure that you get the most from your product.

WARNINGS

- ⚠ WARNING: Read this entire manual before assembly or operation.**
- ⚠ WARNING: Periodically inspect all parts and replace as needed.**
- ⚠ WARNING: DO NOT use near an open flame, as the recliner could be a combustion source, resulting in fire, property damage, and severe personal injury.**
- ⚠ WARNING: Service and repair of the Lumex 574G 3-Position Recliner MUST be performed by an authorized Lumex distributor. GF Health Products, Inc. is not responsible for any consequence resulting from any unauthorized service or repair.**
- ⚠ WARNING: This product has a maximum weight capacity of 250 lb (113.4 kg), EVENLY DISTRIBUTED.**
- ⚠ WARNING: Rear casters must be locked at all times, except during transport. Rear casters must be locked during patient transfer.**
- ⚠ WARNING: Unauthorized modification of your recliner or the use of non-Lumex replacement parts may change the structure of the recliner and could create a hazardous condition, which may result in serious injury and will void the warranty.**
- ⚠ WARNING: GF Health Products, Inc. specifically disclaims responsibility for any bodily injury or property damage which may occur during any use which does not comply with federal, state or local laws or ordinances.**

FEATURES

The 574G 3-Position Recliner is shown below, with main features labeled.



3-Position Recliner Series 574G

ASSEMBLY

UNPACKING INSTRUCTIONS

Unpack and inspect contents for shipping damage or missing parts. If parts are damaged or missing, contact your Lumex distributor immediately.

ASSEMBLY INSTRUCTIONS

Back to Frame Assembly (Refer to Picture at Right)

1. Remove the upholstered backrest and place on a flat surface with the backside facing up.
2. Remove the Push Handle from the bottom of the box.
3. Align the top holes on the push handle with the top holes on the upholstered back.
4. Insert the long screws thru the push bar frame into upholstered back and tighten all screws with a screwdriver.
5. Slide the back assembly into the lower frame assembly square tubes as shown so that the back holes line up with the lower frame horizontal brace holes.
6. Raise the position stabilization bar and adjust back assembly position until lock release button positively engages position stabilization bar link middle slot when chair is in storage position.
7. Insert long screws through horizontal brace holes and tighten all screws with screwdriver.

⚠ WARNING: Ensure the top screw on each side of the back assembly square tubing is completely secure before using recliner.

Upholstered Legrest Assembly

1. Remove the one-piece upholstered footrest from the box.
2. Recline the chair mechanism to make it easier to install the footrest.
3. Set the upholstered footrest onto the footrest frame and align the 4 mounting holes to the upholstered footrest mounting holes.
4. Insert long screws through the frame and into the upholstered footrest. Tighten all screws with screwdriver.



Back to Frame Assembly



Front Caster to Frame Assembly (Refer to Picture at Right)

⚠ WARNING: Perform the following step only with assistance. Lifting the recliner alone could cause personal injury.

1. Set the recliner upside down with the frame legs facing up.
2. Insert fixed front caster assemblies into recliner frame front legs until spring buttons pop out of the openings on each side (as shown in Front Caster to Frame Assembly).

Rear Caster to Frame Assembly (Refer to Pictures at Right)

Tools required: two 7/16" wrenches

1. Insert rear locking caster assemblies into rear recliner frame, while aligning caster stem hole and rear frame hole as shown at right, until holes are aligned.
2. Secure rear caster attachment hardware from outside of recliner through both rear frame and both caster stems as shown.
3. Use two 7/16" wrenches to secure rear caster attachment hardware.

⚠ WARNING: Perform the following step only with assistance. Lifting the recliner alone could cause personal injury.

Set the recliner right side up with the casters down.
The recliner is now ready for operation.

⚠ WARNING: Ensure the recliner is assembled as described and all components are secure before use.

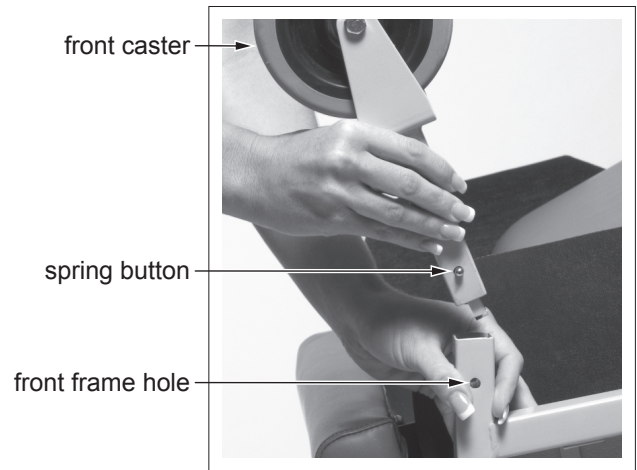

Front Caster to Frame Assembly

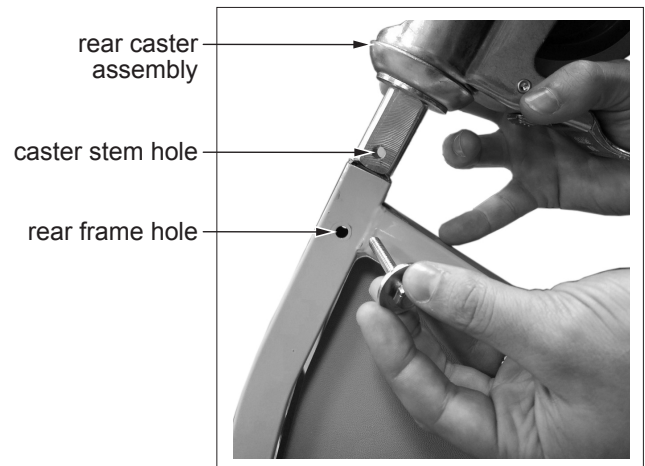

Rear Caster to Frame Assembly

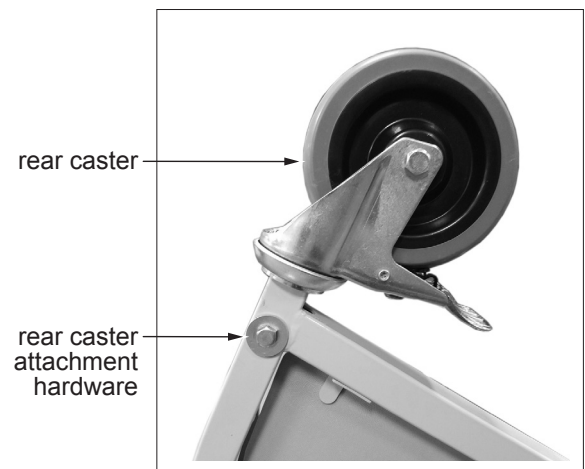

Secure Rear Caster

OPERATION

CASTER OPERATION

⚠ WARNING: Rear casters must be locked at all times, except during transport.

The Lumex 3-Position Recliner features 5" casters specifically designed for use in healthcare environments: two front non-locking fixed casters and two rear locking swivel casters.

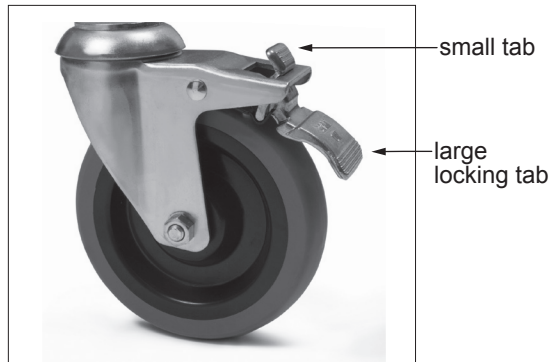

Rear Caster Shown Locked



Rear Caster Shown Unlocked

To Operate Rear Swivel Locking Casters

See photos above.

To Lock the Rear Caster: Depress the large locking tab located at the back of the caster. This will lock both the caster and the swivel function.

To Unlock the Rear Caster: Depress the small tab located on the caster body. This will unlock both the caster and the swivel function.

RECLINER OPERATION



The recliner, shown at above left in upright position and above right in first recline position (TV position), has three positions that can be achieved through the following instructions.

▲ NOTICE: Do not attempt to change recliner position when position stabilization bar is engaged – this could cause damage to the recline mechanism.

Reclining by User

- **Recline:** Place hands on armrests and push your body against recliner back to recline yourself to desired position. Legrest will automatically adjust to recline position.
- **Return to upright position:** Place hands on armrests and pull yourself up while leaning your body forward away from the recliner back and at the same time pushing your legs down evenly on the legrest.

Reclining by Caregiver

Refer to picture at right.

⚠ WARNING: Ensure position stabilization bar is in stored position.

- **Recline to first recline position (TV position):** Standing on either side of the recliner, grasp the armrest with one hand and push down on padded push handle to recline back to the first recline position. If this is the final desired position, set position stabilization bar.
- **Recline to second recline position (full recline position):** After reclining to first recline position (as instructed in previous paragraph), grasp the armrest with one hand and push down on padded push handle again. If this is the final desired position, set position stabilization bar.
- **Return to upright position:** Pull padded push handle forward. Set position stabilization bar.

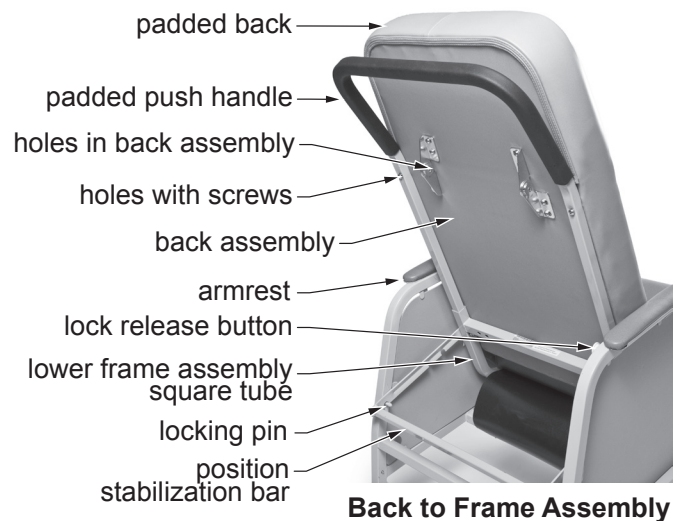

Recliner Position Stabilization

To Stabilize Recliner Position:

Adjust recliner to desired position as described above, pull out lock release button to release position stabilization bar from stored position, and rotate position stabilization bar down until notches are fully engaged over locking pins.

To Release Recliner Position:

Lift position stabilization bar up to disengage from locking pins. While holding lock release, pull button out, rotate position stabilization bar all the way up until completely against seat back. Release lock release pull button to hold position stabilization bar in stored position.

ARTICULATING HEADREST



The user or caregiver may adjust the articulating headrest to the desired position by pulling forward or pushing back.

MOLDED TABLE

Operation

Refer to picture above.

1. Pull table up while holding the pull buttons beneath both arms until the table engages, then slide lock / lockout keys forward on both sides.
2. Pick table up by circular table arm and slide it into the table receiving tubes in the front of each arm. The table can slide on and off by keeping lock / lockout key forward.
3. The table can be secured in one of five positions: Pull down and hold the pull button and slide the key backward. Move other lock / lockout key backward. The table will now be secured.

Storage

The table stores in the table storage tube beneath the left armrest, leaving the table top facing out.

CARE AND MAINTENANCE

⚠ WARNING: Inspect all components periodically and replace as needed.

EVERY THREE MONTHS

- Check and clean casters.
- Tighten bolts in each leg that secure caster into frame.
- Check caster brakes.
- Check and clean position stabilization mechanism.
- Check recliner mechanism for operation in all positions with assistant seated in recliner.

UPHOLSTERY MAINTENANCE AND STAIN REMOVAL

- Ordinary dirt: wash with warm water and a mild soap or detergent.
- Stubborn dirt: using a soft bristle brush, wash with warm water and a mild soap or detergent.
- Ground-in dirt: scrub with powdered cleanser or similar detergent.
- Chewing gum: scrape carefully; remove with kerosene or naphtha.
- Nail polish and remover: Blot immediately to prevent damage.
- Ball point pen: blot immediately with a white cloth dampened in water or mineral oil.
- Paint, shoe polish, heel marks: remove immediately! Use a white cloth dampened in kerosene, naphtha or turpentine. Do not use paint remover or liquid brush cleaners.
- Tars, asphalt, creosote: remove to prevent staining. Clean area with kerosene or naphtha.

⚠ WARNING: When using kerosene or naphtha, do so in a well ventilated area and keep away from fire and flame.

- Waxing and refinishing: improves wearability. Use any quality paste wax.
- A diluted solution of 10% (or less) of bleach or Clorox may be used when cleaning this recliner.

CDC RECOMMENDATIONS

CLEANING AND DISINFECTING STRATEGIES FOR ENVIRONMENTAL SURFACES IN PATIENT-CARE AREAS FOR VINYL UPHOLSTERY, WALL COVERINGS AND FLOORING

- Select EPA-registered disinfectants, if available, and use them in accordance with the manufacturer's instructions.
- Do not use high-level disinfectants/liquid chemical sterilants for disinfection of either noncritical instruments and devices or any environmental surfaces; such use is counter to label instructions for these toxic chemicals.
- Follow manufacturers' instructions for cleaning and maintaining noncritical medical equipment.

- In the absence of a manufacturer's cleaning instructions, follow certain procedures:
 - Clean noncritical medical equipment surfaces with a detergent/disinfectant.
 - Do not use alcohol to disinfect large environmental surfaces.
 - Use barrier protective coverings as appropriate for noncritical surfaces that are:
 - Touched frequently with gloved hands during the delivery of patient care.
 - Likely to become contaminated with blood or body substances.
 - Difficult to clean (e.g., computer keyboards).
- Keep housekeeping surfaces (e.g., floors, walls, tabletops) visibly clean on a regular basis and clean up spills promptly.
- Use a one-step process and an EPA-registered hospital detergent/disinfectant designed for general housekeeping purposes in patient-care areas where:
 - Uncertainty exists as to the nature of the soil on the surfaces (whether it is blood or body fluid or just normal dust or dirt).
 - Uncertainty exists regarding the presence of multi drug resistant organisms on such surfaces.
- Detergent and water are adequate for cleaning surfaces in nonpatient-care areas (e.g., administrative offices). Clean and disinfect high-touch surfaces on a more frequent schedule than minimal-touch housekeeping surfaces. Clean walls, blinds, and window curtains in patient-care areas when they are visibly dusty or soiled.
- Do not perform disinfectant fogging in patient-care areas.
- Avoid large-surface cleaning methods that produce mists or aerosols, or disperse dust in patient-care areas.
- Follow proper procedures for effective uses of mops, cloths, and solutions.
 - Prepare cleaning solutions daily or as needed, and replace with fresh solution frequently according to facility policies and procedures.
 - Change the mop head at the beginning of each day and also as required by facility policy, or after cleaning up large spills of blood or other body substances.
 - Clean mops and cloths after use and allow to dry before reuse; or use single-use, disposable mop heads and cloths.
- When performing low- or intermediate-level disinfection of environmental surfaces in nurseries and neonatal units, avoid unnecessary exposure of neonates to disinfectant residues on these surfaces by using EPA-registered germicides in accordance with manufacturers' instructions and safety advisories.

DISPOSAL AND KEY TO SYMBOLS

DISPOSAL

Lumex Recliner equipment and accessories can be disposed of.







We recommend disassembling and dividing the equipment and components into different waste groups such as: metal, cable, electronic, recoverable resource and plastic for recycling or combustion.





Most plastic components are provided with a plastic types code and fiber content to aid sorting of plastic parts.

Product	Metal Scrap	Cable Scrap	Electronic Scrap	Plastic Recycling or Combustion
574G	X	X	N/A	X

KEY TO SYMBOLS

The following symbols are used on Lumex Recliner product labels.

	MANUFACTURER
	FRAGILE, HANDLE WITH CARE
	CE MARK
	CAUTION
	EUROPEAN AUTHORIZED REPRESENTATIVE
	UNIQUE DEVICE IDENTIFIER

	GENERAL WARNING SIGN
	KEEP DRY
	ELECTRICAL AND ELECTRONIC EQUIPMENT
	CONSULT INSTRUCTIONS FOR USE
	MEDICAL DEVICE

TECHNICAL SPECIFICATIONS

Specification	Model 574G
Overall Height	45.5" (115.6 cm)
Overall Width	24.5" (62.2 cm)
Overall Depth	41" (104.1 cm)
Width Between Arms	20" (50.8 cm)
Arm Height from Floor	26" (66.0 cm)
Arm Height from Seat	8" (20.3 cm)
Seat Height	20" (50.8 cm)
Seat Width	19" (48.3 cm)
Seat Depth	20" (50.8 cm)
Shipping Weight	87 lb (39.5 kg)
Maximum Weight Capacity	250 lb (113.4 kg), EVENLY DISTRIBUTED

For complete technical specifications, call the GF Technical Support Group at 1.770.368.4700.

LIMITED WARRANTY

SCOPE OF WARRANTY

GF Health Products, Inc. ("GF") warrants to the original purchaser only that it will replace or repair components, at GF's sole discretion, that are defective in material or workmanship under normal use and service. All warranties are conditioned upon the proper use of the products strictly in accordance with good commercial practice and applicable GF instructions and manuals, including proper use and maintenance. To the extent that a third party warrants a component, GF conveys all of its rights under that warranty to the original purchaser, to the extent permitted. This limited warranty shall only apply to defects that are reported in accordance with the provisions set forth in this warranty document, within the applicable warranty period and which, upon examination by GF or its authorized representative, prove to be a warranty item. (See Obtaining Warranty Service below) This limited warranty is not transferable.

The warranted components and time periods are set forth below:

Frame:.....two years

Casters:.....one year

Upholstery:.....one year

All other components:.....one year

* Labor is not included in the warranty.

† Upholstery is only warranted on material supplied by GF.

‡ The warranty period is as designated above. If a part is replaced under warranty, the original warranty period will not be affected. All other replacement parts will be subject to the warranty period specified.

The applicable warranty period shall commence from date of shipment to the original customer, unless there is an expiration date on the component in which case the warranty shall expire on the earlier of warranty period or the expiration date.

OBTAINING WARRANTY SERVICE

Customers located in the United States who wish to report a warranty issue, must contact GF directly by calling 1.770.368.4700 or by e-mailing a request to cs@grahamfield.com. Customers located outside the United States must contact the Distributor from whom they purchased the products. In both cases, further directions will be provided once the initial contact is made. This limited warranty shall only apply to defects that are reported within the applicable warranty period. Failure to abide by the specific directions will result in denial of the warranty claim.

The warranty does not cover and GF shall not be liable for the following:

1. Defects, damage, or other conditions caused, in whole or in part, by misuse, abuse, negligence, alteration, accident, freight damage, tampering or failure to seek and obtain repair or replacement in a timely manner;
2. Products which are not installed, used, or properly cleaned and maintained as required in the official manual for the applicable product;
3. Products considered to be of a non-durable nature including, but not limited to: filters, fuses, gaskets, lubricants, and charts;
4. Accessories or parts not provided by GF;
5. Matching of color, grain or texture except to commercially acceptable standards;
6. Changes in color caused by natural or artificial light;
7. Charges by anyone for adjustments, repairs, replacement parts, installation or other work performed upon or in connection with such products which are not expressly authorized in writing, in advance, by GF;
8. Any labor or shipping charges incurred in the replacement part installation or repair;
9. Costs and expenses of regular maintenance and cleaning; and
10. Representations and warranties made by any person or entity other than GF.

ENTIRE WARRANTY, EXCLUSIVE REMEDY AND CONSEQUENTIAL DAMAGES DISCLAIMER

THIS WARRANTY IS GF'S ONLY WARRANTY AND IS IN LIEU OF ALL OTHER WARRANTIES, EXPRESS OR IMPLIED. GF MAKES NO IMPLIED WARRANTIES OF ANY KIND INCLUDING ANY IMPLIED WARRANTIES OF MERCHANTABILITY OR FITNESS FOR A PARTICULAR PURPOSE. IF ANY MODEL OR SAMPLE WAS SHOWN TO THE CUSTOMER, SUCH MODEL OR SAMPLE WAS USED MERELY TO ILLUSTRATE THE GENERAL TYPE AND QUALITY OF THE PRODUCT AND NOT TO REPRESENT THAT THE PRODUCT WOULD NECESSARILY CONFORM TO THE MODEL OR SAMPLE IN ALL RESPECTS. THIS WARRANTY IS LIMITED TO THE REPAIR OR REPLACEMENT OF THE DEFECTIVE PARTS. GF SHALL NOT BE LIABLE FOR AND HEREBY DISCLAIMS ANY DIRECT, SPECIAL, INDIRECT, INCIDENTAL, EXEMPLARY OR CONSEQUENTIAL DAMAGES, INCLUDING, BUT NOT LIMITED TO: DAMAGES FOR LOSS OF PROFITS OR INCOME, LOSS OF USE, DOWNTIME, COVER, OR EMPLOYEE OR INDEPENDENT CONTRACTOR WAGES, PAYMENTS AND BENEFITS. CERTAIN STATES MAY CONFER ADDITIONAL RIGHTS REGARDING WARRANTIES AND IN THOSE STATES GF'S LIABILITY AND THE LIABILITY OF GF'S SUPPLIERS, SHALL BE LIMITED TO THE FULLEST EXTENT PERMITTED BY LAW.

The warranties contained herein, together with GF's current Terms and Conditions, contain all the representations and warranties with respect to the subject matter of this document, and supersede all prior negotiations, agreements and understandings with respect thereto. The recipient of this document hereby acknowledges and represents that it has not relied on any representation, assertion, guarantee, warranty, collateral contract or other assurance, except those set out in this document.

For additional information on this product or this warranty, please contact a GF Customer Service Representative.

NOTES:

1. Additional terms and conditions may apply. See GF's General Terms and Conditions on its website: www.grahamfield.com.
2. Freight claims must be notated on the appropriate shipping documents and must be made with immediacy. International, federal and state regulations govern specific requirements for freight claims. Failure to abide by those regulations may result in a denial of the freight claim. GF will assist you in filing the freight claim.
3. Claims for any short shipment must be made within three (3) days of the invoice date.

INDEX

A

Assembly 6

B

Back to frame assembly 6

C

Care and maintenance 11

Caster operation 8

Caster operation, rear swivel locking 8

Caster, rear, lock 8

Caster, rear, unlock 8

CAUTION statement, significance 3

D

Disposal 13

F

Features 5

Front caster to frame assembly 7

H

Headrest, articulating 10

I

Important safety precautions 3

Info statement, significance 3

Intended use 3

Introduction 3

K

Key to symbols 13

L

Limited warranty 14

N

NOTICE statement, significance 3

O

Operation 8

R

Rear caster to frame assembly 7

Recliner operation 8

Recliner position stabilization 9

Reclining by caregiver 9

Reclining by user 9

S

Symbol key 13

T

Table, molded, operation 10

Table, molded, storage 10

Technical specifications 13

U

Unpacking instructions 6

Upholstery maintenance and stain removal 11

W

WARNINGS 3

WARNING statement, significance 3

Warranty, limited 14

LUMEX[®]

by graham-field

Manufactured For:
GF Health Products, Inc.
1 Graham-Field Way, Atlanta, GA 30340
Made in Taiwan

© 2014, GF Health Products, Inc. All Rights Reserved.
Lumex is a registered trademark of GF Health Products, Inc.

LX_574G-INS-LAB-RevG25



+1 770.368.4700

Information contained herein is subject to change without notice.
The most current and complete product information can be found on our website.
www.grahamfield.com

graham
 **field[™]**