



**CLINICAL CARE RECLINERS SERIES
IN577RG,
IN577RGH (WITH HEAT & MASSAGE),
AND
IN577RGHO (WITH HEAT ONLY)
ASSEMBLY AND OPERATING
INSTRUCTIONS**

SAVE THIS MANUAL FOR FUTURE USE.

CONTENTS

INTRODUCTION	3
INTENDED USE	3
IMPORTANT SAFETY PRECAUTIONS – PLEASE READ BEFORE USE	3
WARNINGS.....	3
ASSEMBLY	5
UNPACKING	5
PRODUCT DESCRIPTION	5
UPHOLSTERED BACK ASSEMBLY	5
OPERATION	8
TENTE® CASTERS.....	8
SIDE TABLE OPERATION	8
TO RAISE TABLE	8
TO LOWER TABLE	8
SIDE PANEL OPERATION	9
TO REMOVE SIDE PANEL	9
TO INSTALL SIDE PANEL.....	9
RECLINER OPERATION.....	9
FIRST POSITION (UPRIGHT POSITION)	9
SECOND POSITION (FIRST RECLINE POSITION)	9
THIRD POSITION (SECOND RECLINE POSITION)	10
ARTICULATING HEADREST	10
TRENDLENBURG POSITION (ALSO KNOWN AS SHOCK POSITION).....	10
GAS SPRING TROUBLESHOOTING GUIDE.....	11
ADJUSTING CABLE TENSION.....	11
LUMEX FR577RGH WITH HEAT AND MASSAGE FEATURE	12
INSTALLATION AND OPERATING GUIDE	12
DESCRIPTION.....	12
CONNECTION	12
MAIN COMPONENTS	12
HEAT AND MASSAGE INSTALLATION INSTRUCTIONS.....	13
HEAT AND MASSAGE UNIT OPERATION INSTRUCTIONS FOR GEN 3 UNIT.....	15
HEAT AND MASSAGE UNIT TROUBLESHOOTING GUIDE.....	17
CARE AND MAINTENANCE.....	18
EVERY THREE MONTHS	18
UPHOLSTERY MAINTENANCE AND STAIN REMOVAL	18
PERMABLOK3® CARE AND CLEANING GUIDE – ADVANCED VINYL PROTECTION	18
CDC RECOMMENDATIONS	19
DISPOSAL AND KEY TO SYMBOLS	20
DISPOSAL.....	20
KEY TO SYMBOLS.....	20
CE CERTIFICATION	21
TECHNICAL SPECIFICATIONS.....	21
LIMITED WARRANTY	22
INDEX	23



INTRODUCTION

This manual contains assembly, operation, and maintenance instructions for the Lumex Clinical Care Recliners Series FR577RG (Models FR577RG, FR577RGH, and FR577RGHO). Read the entire manual carefully before using your recliner, and refer to it during use if you have questions. If you have further questions, please call Graham-Field / Lumex Technical Support at 1.770.368.4700.

INTENDED USE

Lumex Clinical Care Recliners are intended to make the care, treatment and recovery of patients easier and more comfortable. Lumex Clinical Care Recliners are used in a wide range of healthcare applications including Dialysis, Oncology, Drug Delivery, Same Day Surgery and Post-Operative Recovery. Lumex Clinical Care Recliners are ideal for use in hospitals, clinics and rehabilitation centers.

Lumex Series FR577RG recliners support patient weights up to 350 lb (158.76 kg), EVENLY DISTRIBUTED.

IMPORTANT SAFETY PRECAUTIONS—PLEASE READ BEFORE USE

The safety statements presented in this chapter refer to the basic safety information that the Series FR577RG user must pay attention to and abide by. There are additional safety statements in other chapters or sections, which may be the same as or similar to the following, or specific to the operations. Please note the following special statements, used throughout this manual, and their significance:

- ⚠ WARNING: Indicates a potential hazard situation or unsafe practice that, if not avoided, could result in death or serious personal injury.**
- ⚠ CAUTION: Indicates a potential hazard or unsafe practice that, if not avoided, could result in minor or moderate personal injury.**
- ▲ NOTICE: Indicates a potential hazard or unsafe practice that, if not avoided, could result in product or property damage.**

Info: Provides application recommendations or other useful information to ensure that you get the most from your product.

WARNINGS

- ⚠ WARNING: Read this entire manual before assembly or operation.**
- ⚠ WARNING: Periodically inspect all parts and replace as needed.**
- ⚠ WARNING: Do not use near an open flame, as the chair could be a combustion source, resulting in fire, property damage, and severe physical injury.**
- ⚠ WARNING: Service and repair of the Lumex Series FR577RG Clinical Care Recliner must be performed by a Graham-Field authorized distributor. GF Health Products, Inc. is not responsible for any consequence resulting from any unauthorized service or repair.**
- ⚠ WARNING: The electronics and actuator contain no serviceable components. If service is required, the unit must be returned to the factory for repair. DO NOT attempt to open the electronics or actuator or obtain local service; this will void the warranty and may result in damage to the unit. Consult your Graham-Field authorized distributor for further information.**

- ⚠ WARNING: This product has a maximum weight capacity of 350 lb (158.76 kg), EVENLY DISTRIBUTED.**
- ⚠ WARNING: Casters must be locked at all times to prevent unwanted movements.**
- ⚠ WARNING: Unauthorized modification of your recliner or the use of non-Lumex replacement parts may change the structure of the recliner and could create a hazardous condition, which may result in serious injury and will void the warranty.**
- ⚠ WARNING: GF Health Products, Inc. specifically disclaims responsibility for any bodily injury or property damage which may occur during any use which does not comply with federal, state or local laws or ordinances.**

ASSEMBLY

UNPACKING

1. Check for obvious damage to the carton or its contents. If damage is evident, please notify the carrier and your Graham-Field authorized distributor.
2. Remove all packaging materials from recliner base.

PRODUCT DESCRIPTION

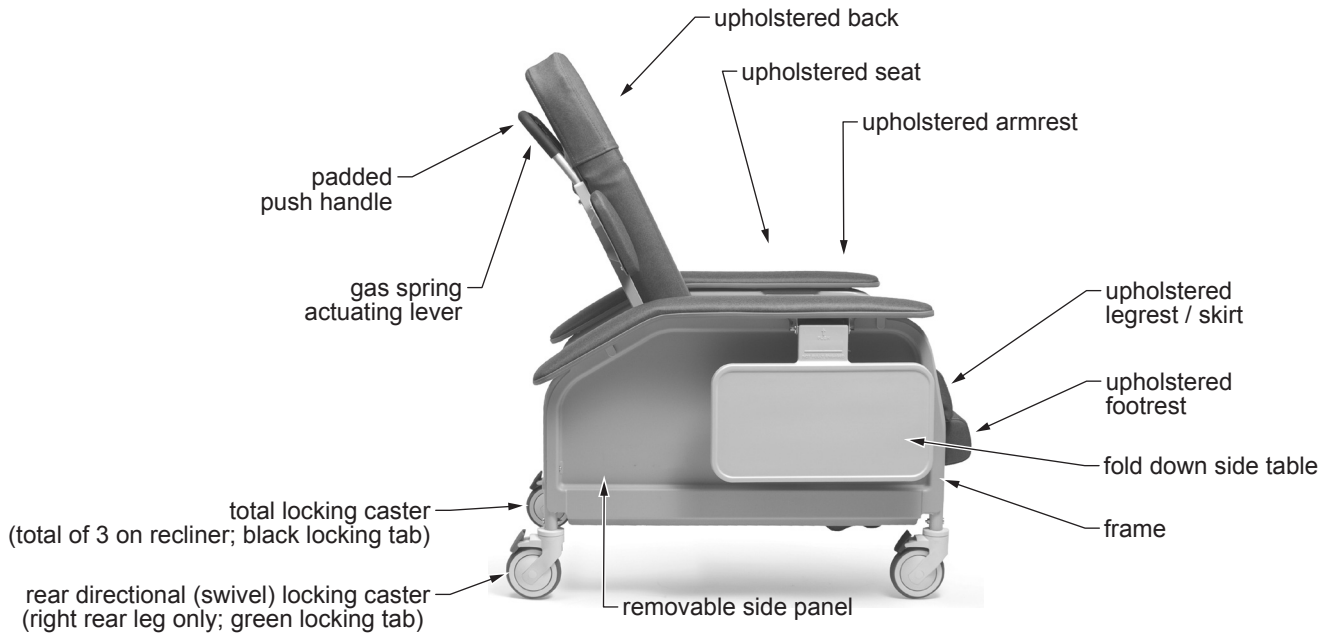

Clinical Care Recliner Series FR577RG

Upholstered Back Assembly

1. After removing all components from the carton, engage all four locks on the casters before beginning assembly.
2. Back Assembly at right shows the location of three clevis pins, two ring cotter clips and two large cotter pins.

Info: The three center clevis pins are 5/16" in diameter. The two outside clevis pins are 3/8" in diameter.

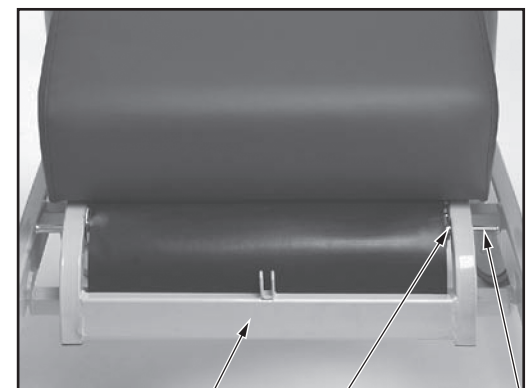

Back Assembly

- Remove cardboard shipping retainers and tape from around gas spring cylinder. Rotate the gas spring hinge section so that it is perpendicular to the upholstered back, as shown at right.

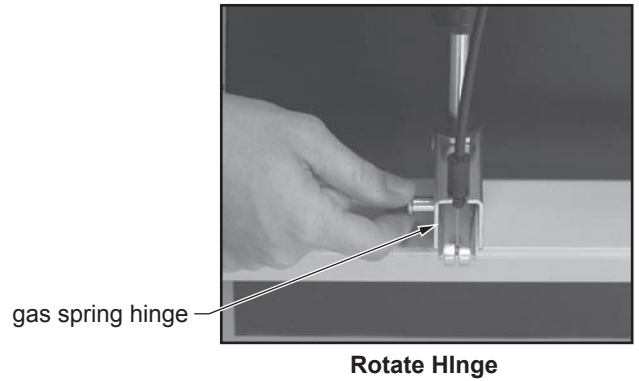

- Remove upholstered side panels from frame: Depress the two push buttons located on the lower sides of frame. Pull side panel gently away and down from frame. There are tabs on the frame underneath the armrest that hold the side panel in place.

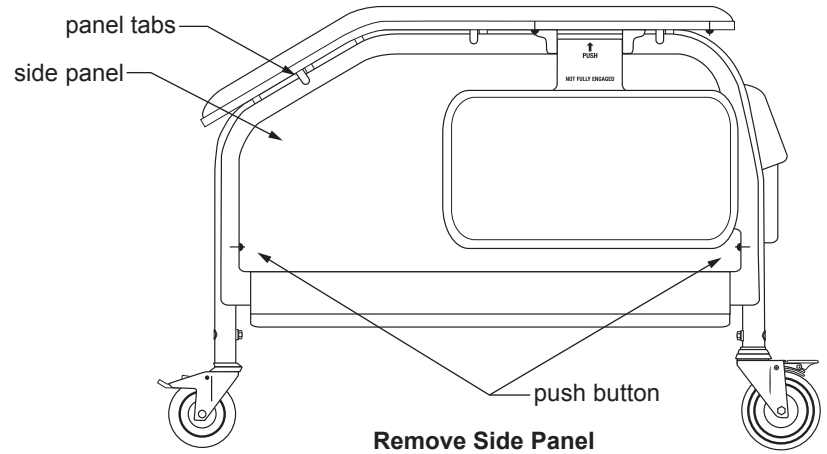

- Lift the upholstered back from the sides and place it horizontally with the upright back tubes resting on the recliner frame.

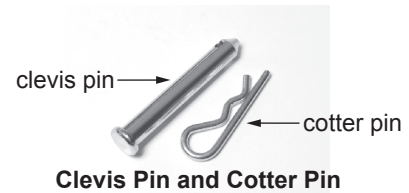

- Align the holes on the upright back tubes of the upholstered back with the holes on the seat frame. Place the 3/8" diameter clevis pins through the mounting holes in the frame and back as shown at right.

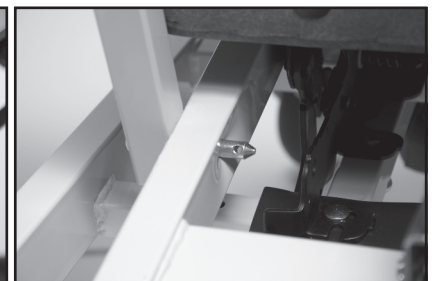

- Secure the two clevis pins by placing a large cotter pin through the hole in the clevis pin (one for each side) as shown at right.

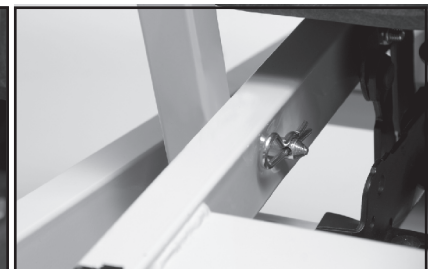

8. Raise the upholstered back to vertical position. Tuck the plastic skirt at rear of upholstered back behind cross brace of seat frame. Align the hinges at the bottom of the gas spring with the holes in the U-brackets on the seat frame cross brace. While holding the back in position with one hand, secure the gas spring hinge to the U-bracket by placing the 5/16" diameter clevis pins through the U-bracket and hinge with the other hand.

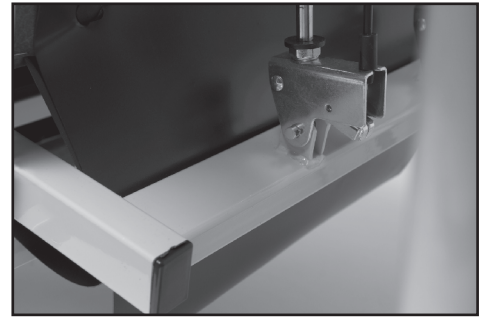

Place Clevis Pins

9. Secure the clevis pin by placing the ring cotter pin through the hole in the clevis pin as shown at right.

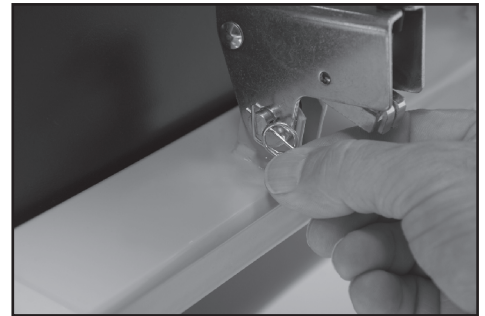

Place Cotter Pins

10. Replace side panels:
Insert side panel into recliner frame by locating the tabs underneath the armrest. Make sure side panel is properly aligned and that the top edge is behind the locking tabs. Press side panel into frame sides. Make sure that both push buttons are protruding into side panel to ensure side panel is locked in place.

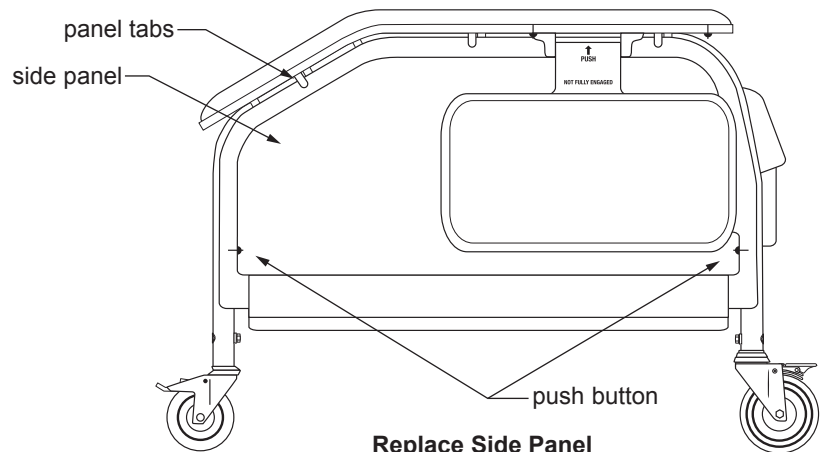

Replace Side Panel

OPERATION

⚠ WARNING: Disconnection of the Device: In case of emergency, always disconnect the device by removing the power cord plug from the power outlet.

TENTE® CASTERS

⚠ WARNING: Casters must be locked at all times to prevent unwanted movements.

All Lumex Clinical Care Recliners now feature the latest design, all-plastic casters from TENTE. Specifically designed for use in healthcare environments, the new casters are easier to clean, easier to move, and tolerate a wide array of cleaners and chemicals. Each caster is made from high-grade synthetic materials and features a double-ball bearing swivel head. The wheel center is made of polypropylene and the tire tread of TENTEprene (thermoplastic rubber). The gray non-marking tires feature precision ball bearings.

Locking casters: Each Lumex Clinical Care Recliner features three total locking casters, identified by black actuator tabs, that lock both the wheel and the swivel.

To activate the total lock, simply press down on the BLACK actuator tab until it locks. To release the total lock, press on the raised portion of the actuator tab until the lever is back in the normal operating position.

Directional (swivel) caster: The fourth caster, located on the right rear position of the recliner, is a directional (swivel) locking caster only. Identified by a green actuator tab, the directional lock caster will lock in one of two 180-degree positions relative to the frame (forward and backward) and allows the recliner to track straight when pushed. To activate the directional lock, simply press down on the GREEN actuator tab until it locks — you may need to move the recliner slightly until the caster locks in a straight line with the recliner frame. To release the directional lock, press on the raised portion of the actuator tab until the lever is back in the normal operating position.

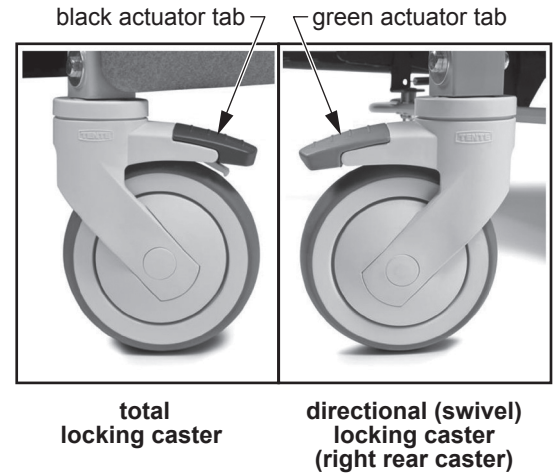

SIDE TABLE OPERATION

To Raise Table

Raise the side table all the way up and slide in toward the armrest until tabs engage slots in mount bracket. Press down lightly on table to ensure locking tabs are engaged.

To Lower Table

Lift the side table up slightly until tabs disengage slots and pull table away from armrest. Lower side table to self-storing position.

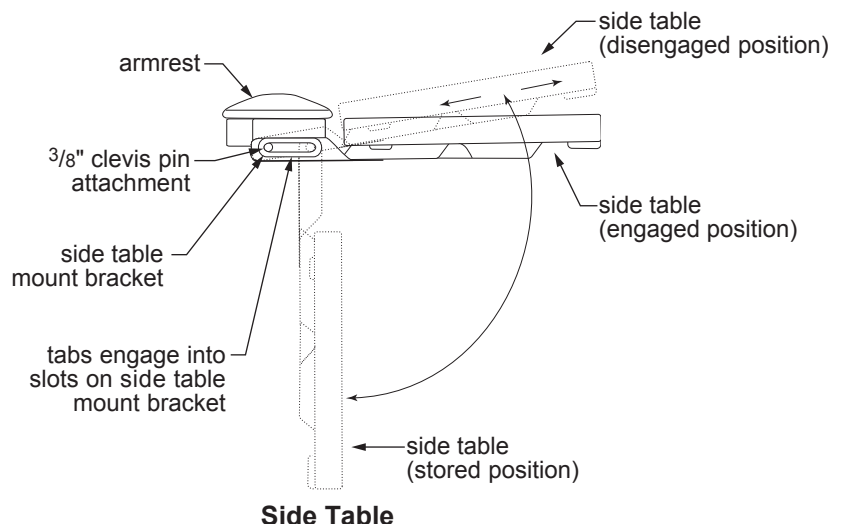

SIDE PANEL OPERATION

For easy cleaning and access to the side / underside of the recliner, Lumex Clinical Care Recliners feature easy-to-remove side panels.

To Remove Side Panel

Depress the two push buttons located on the lower sides of frame. Pull side panel gently away and down from frame. There are tabs on the frame underneath the armrest that hold the side panel in place.

To Install Side Panel

Insert side panel into recliner frame by locating the tabs underneath the armrest. Make sure side panel is properly aligned and that the top edge is behind the locking tabs. Press side panel into frame sides. Make sure that both push buttons are protruding into side panel to ensure side panel is locked into place.

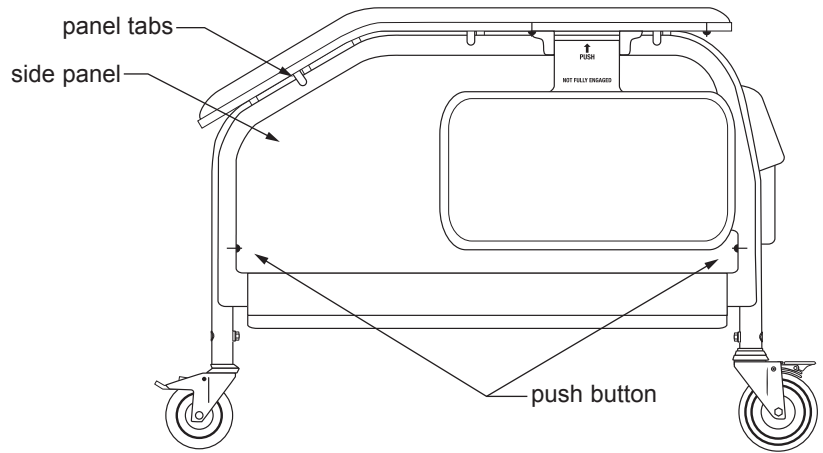

Removable Side Panel

RECLINER OPERATION

The Lumex Series FR577RG Recliners feature three positions for patient comfort. The fourth position is a Trendelenburg (or shock) position that must be activated by a caregiver. The Trendelenburg Position CANNOT be activated by a patient while in the recliner. In addition, the Series FR577RG features a back that can be repositioned via the Adjustment Lever located on the Push Handle on the back of the recliner.

First Position (Upright Position)

The first position is the **Upright Position**. This position is ideal for patient transfer and can be used to initiate patient treatment / therapy.



Upright Position

Second Position (First Recline Position)

The second position is the **First Recline Position** and is also known as the "TV" position. This position is ideal for patient treatment, rest and reading.



First Recline Position (TV Position)

To Achieve Second Position / First Recline Position:

- By the Patient: Place hands on armrest and push body against recliner back to recline yourself to desired position. To bring yourself up, place hands on armrest and pull yourself up while leaning your body forward, away from the recliner back, while at the same time pushing down evenly on the footrest with your legs.
- Reclining by Attendant: Standing on either side of the recliner, grasp the armrest with one hand and push handle with the other hand. Push back on push handle to recline. To return, grasp push handle and pull forward to raise the recliner back.

▲ **NOTICE: DO NOT use the footrest by itself to return the recliner to an upright position from any recline position. Doing so may damage the recliner mechanism. Follow the instructions above to operate the recliner.**

Third Position (Second Recline Position)

The third position is the **Second Recline Position** and is also known as the "Full Recline" position. This position is ideal for patient treatment, rest and reading.



**Second Recline Position
(Full Recline Position)**

To Achieve Third Position / Second Recline Position:

- Reclining by patient: From the First Recline Position continue to push against the back by placing your hands on armrests and continue to recline yourself to the Second Recline Position. To bring yourself up, place hands on armrests and pull yourself up while leaning your body forward away from the recliner back while at the same time pushing down evenly on the footrest with your legs.
- Reclining by attendant: Standing on either side of the recliner, grasp the armrest with one hand and push handle with the other hand. Push back on push handle to recline. To return, grasp push handle and pull forward to raise the recliner back.

Articulating Headrest

The Series FR577RG features an articulating headrest for additional patient comfort. The upper section of the back features a self-contained headrest, shown at right. To reposition the headrest section, from the recliner front, pull forward on the upper section of the back to increase the angle of the headrest section. To return headrest to normal position, push headrest section back so that it is even with the back of the recliner.



Articulating Headrest

Move Headrest Forward

Trendelenburg Position (Also Known as Shock Position)

Info: This position can only be achieved by a caregiver.

Refer to picture at right. Standing at the back of the recliner, grasp the push handle with one hand while actuating the lever located on the rear push handle with the other. Slowly guide the back down fully until it stops and release the lever. If the articulating headrest is in the forward position, push it back so that it is even with the back of the recliner. The Trendelenburg Position can be obtained from any position.

To bring recliner out of Trendelenburg, stand at the back of the recliner and actuate the lever. Slowly guide the back upright and release the lever. Recliner can then be placed in the desired position.



Lever



**Trendelenburg Position
(Shock Position)**

GAS SPRING TROUBLESHOOTING GUIDE

Info: The gas spring has been pre-adjusted at the factory.

The gas spring on your recliner provides counterbalancing forces, and is self-locking for infinite, precise positioning. Unlocking the gas spring is controlled by actuating the lever located on the padded push handle on the back of the recliner, shown at right. When the lever is actuated it pulls on the cable which in turn pulls on a hinge, depressing a button at the end of the gas spring rod. If the gas spring does not unlock when the lever is actuated or if it remains permanently unlocked when the lever is actuated, the cable must be adjusted.

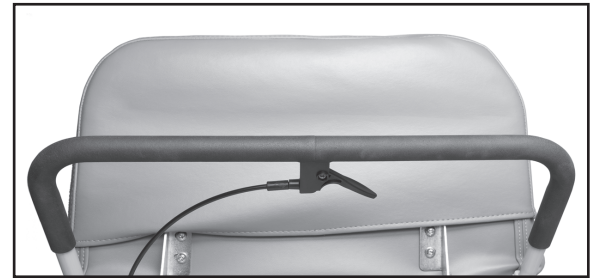

Lever

Adjusting Cable Tension

1. Remove the one screw and cable clip which secures the cable to the upholstered back. Remove the gas spring from the recliner by disassembling the two ring cotter pins and the two clevis pins that secure the gas spring to the back / frame.
2. Lower the back until it rests on the stop bars on the recliner frame. Loosen the lock nut on the gas spring.
3. Hold the hinge assembly while turning the gas spring until the cable just becomes taut. Back off the gas spring an additional half turn.

Info: If the gas spring was not unlocking when the lever was actuated, the gas spring must be turned clockwise. If the gas spring was not locking when the lever was released, the gas spring must be turned counter-clockwise.

4. Retighten the lock nut.
5. Reassemble the gas spring to the back of the recliner by replacing the clevis pins, bridge pins, and re-attach cable to back of recliner with the screw and cable clip.
6. Actuate the recliner in accordance with the operating instructions to verify correct adjustment.

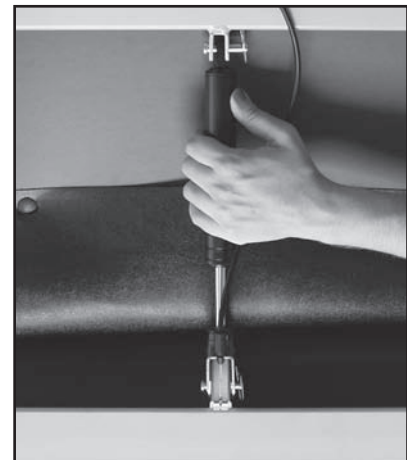

Adjusting Cable Tension 1

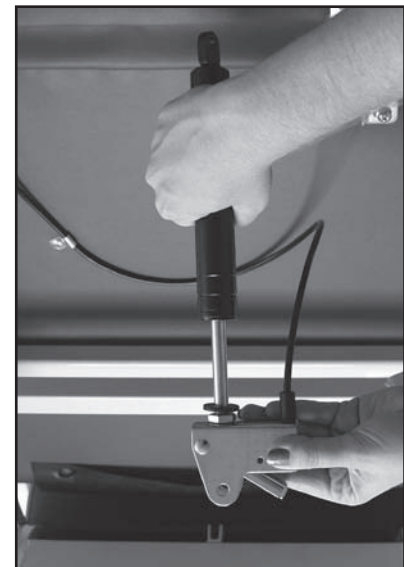

Adjusting Cable Tension 2

RECLINERS WITH HEAT AND MASSAGE OR HEAT ONLY FEATURE

HEAT AND MASSAGE: FR577RGH; HEAT ONLY: FR577RGHO

INSTALLATION AND OPERATING GUIDE

- ⚠ **WARNING: Important! Read and understand these instructions before assembling or using the Specialty Healthcare Seating Heat and Massage / Heat Only Unit. If you do not understand any part of these warnings, cautions or instructions, contact a healthcare professional for direction in the use of this product. If the Heat and Massage / Heat Only Unit is not properly assembled, personal injury and damage to the Heat and Massage / Heat Only Unit could result.**
- ⚠ **WARNING: The recliner seat and back heating elements are wired to operate in series only. Do not change the system wiring in any way.**
- ⚠ **WARNING: If components are damaged or missing, contact your Graham-Field authorized distributor immediately. DO NOT use substitute parts. Use only Lumex replacement parts. The use of non-Lumex replacement parts could cause personal injury, property damage, and void the warranty.**
- ⚠ **WARNING: GF Health Products, Inc. assumes no responsibility for any damage or injury caused by improper assembly or use of this product.**

Description

The Lumex Healthcare Seating Heat and Massage / Heat Only Unit is a low-voltage (12V) Heat and Massage / Heat Only Unit, controllable by the user and / or caregiver via a handheld pendant. It is designed to enhance the comfort of the patient / resident during the use of Lumex Clinical Care Recliners. The Heat and Massage Unit offers three levels of seat and back heat, as well as a gentle or firm massage function for just the lower back or both lower and upper back; the Heat Only Unit offers three levels of seat and back heat.

Connection

The Heat and Massage Unit comes pre-installed in Lumex Clinical Care Recliners with the Heat and Massage Option (FR577RGH); the Heat Only Unit comes pre-installed in Lumex Clinical Care Recliners with the Heat Only Option (FR577RGHO).

Info: Model FR577RGH requires two connections; one for the massage motor and the other at the control box.

Main Components

1. All Heat and Massage / Heat Only functions are controlled by the handheld pendant.

The handheld pendant comes pre-installed and is wrapped to the bottom of the seat. To store the pendant when not in use or for caregiver use, place it in the pendant storage bracket mounted on the back of the recliner as shown at right.



Handheld Heat and Massage Pendant Shown in Storage Bracket on Back of Recliner

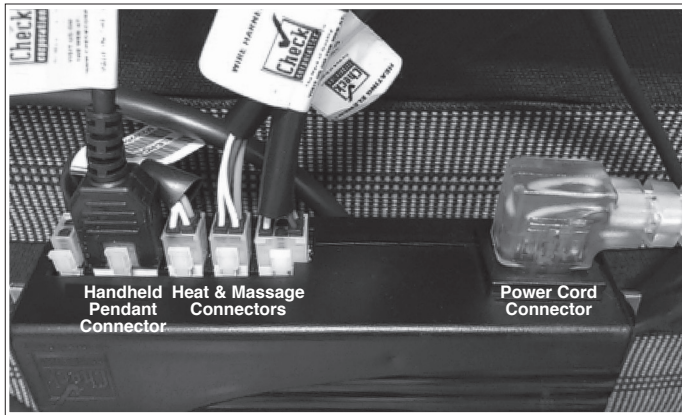

**Heat and Massage Feature —
Control Module and Transformer Unit
Showing All Connections Correctly Made**

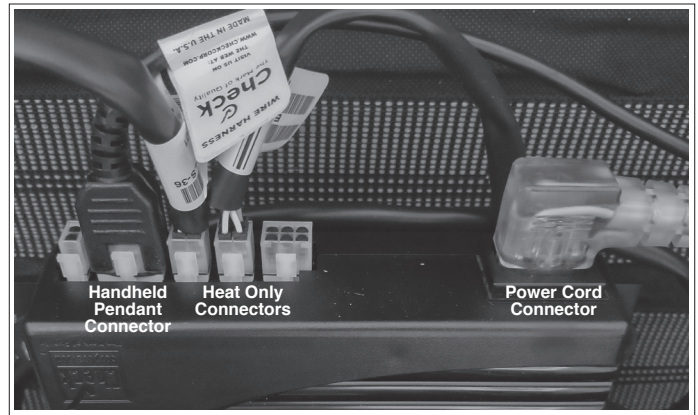

**Heat Only Feature —
Control Module and Transformer Unit
Showing All Connections Correctly Made**

2. The Control Module and Transformer, shown above, are contained in a single unit mounted in the back compartment. The 8-foot power cord plugs into the wall AC outlet.

Heat and Massage / Heat Only Installation Instructions

During recliner shipment, the Heat and Massage cable connections are disconnected. Just two easy connections are required to make the unit functional.

⚠ CAUTION: To prevent personal injury and damage to the recliner always obtain assistance when positioning the recliner as instructed in the following sections.

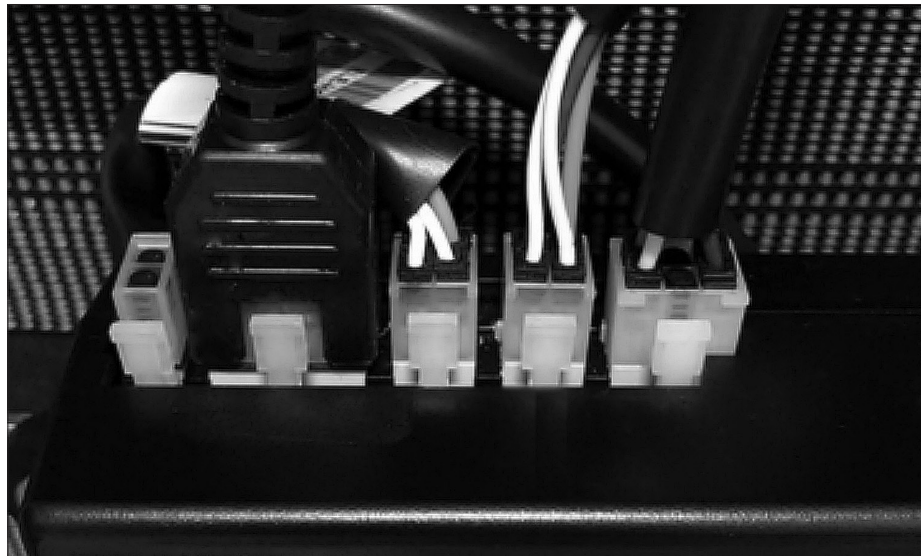

Control Module and Transformer Unit Showing All Connections Correctly Made

1. Install the back assembly and gas spring on the seat frame with the clevis pins and clips supplied with the recliner as indicated in your recliner's Assembly and Operating Manual.

2. Remove the left side table, shown at right, from the recliner to prevent damage to it during setup: Withdraw the ball lock pin, shown at right, and set ball lock pin and table aside.
3. Place a protective cover or drop cloth on your workbench or floor to protect the recliner frame finish and upholstery. With assistance, carefully roll the recliner and rest it on its left side to provide access to the seat bottom, as shown at right. If desired, for better access, you may roll the recliner completely upside down. Carefully extend the footrest partway for access to the components, as shown at right.

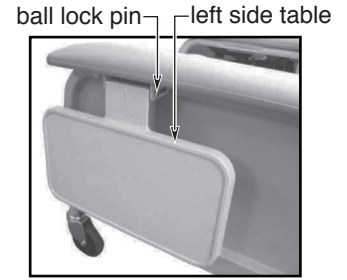

Remove Left Side Table

⚠ WARNING: DO NOT place your hands in the path of the moving recliner mechanism. Moving parts could cause personal injury.

4. Insert the cable connector labeled BACK into the control module connector (see picture of control module on previous page) until its locking tab snaps into place.
5. Locate the black plastic corrugated tube at the lower back of the Recliner.
6. Pull on the red wires coming out of the plastic tube.

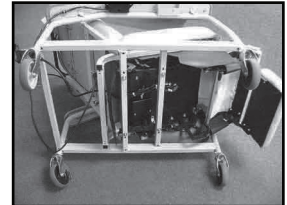

Roll Recliner onto its Left Side

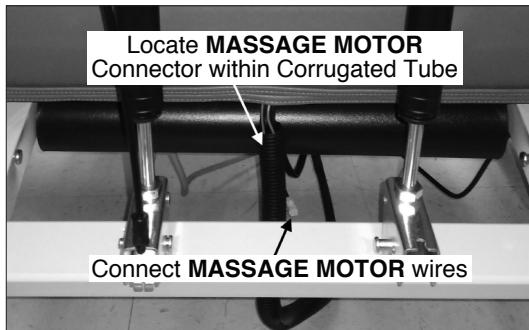

Connect Massage Motor Wires

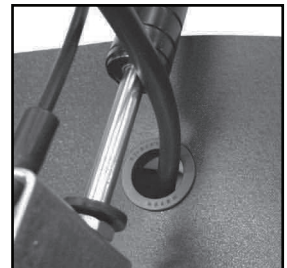

Insert Cable Connector Labeled SEAT Through Bushing

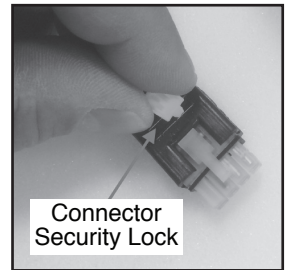

Connector Security Lock

7. There is a connector within the plastic tube labeled "Massage Motors" — connect this connector to the other Massage Motor connector shown above.
8. If you need to replace the Handheld Pendant, remove the small white connector security lock as shown at right.
9. With assistance, carefully return the recliner to its upright position.
10. Reinstall the left side table with the ball lock pin.
11. The Heat and Massage Unit is now ready for operation. Instructions for use follow.

▲ NOTICE: Before rolling the recliner, ensure the power cord is unplugged from the AC outlet.

Heat and Massage Unit Operation Instructions for Gen 3 Unit

1. Plug the power cord into any grounded outlet.



Heat and Massage Handheld Pendant

2. The Heat and Massage Unit is operated using the handheld pendant, shown above.



**Faceplate Selector Switch,
Heat and Massage Handheld Pendant**

3. The Pendant has two membrane switches. The left switch controls the Massage Function and the right switch controls the Heat Function, as shown above on the Handheld Pendant Selector Switch Faceplate. You can use either the Heat or Massage or both functions at the same time.

4. Press the left switch to start the Massage function. The Massage Function Settings are as follows:
 - a) Press selector switch for Setting 1: Gentle Lower Back Massage.
 - b) Press selector switch AGAIN for Setting 2: Firm Lower Back Massage.
 - c) Press selector switch AGAIN for Setting 3: Gentle Upper and Lower Back Massage.
 - d) Press selector switch AGAIN for Setting 4: Firm Upper and Lower Back Massage.
 - e) Press selector switch AGAIN: Massage function Shuts Off.
5. Press the right switch to start the Heat function. The Heat Function Settings are as follows:
 - a) Press selector switch for Setting 1: High Heat, 104°F (40°C), brightest LED.
 - b) Press selector switch AGAIN for Setting 2: Medium Heat, 101°F (38.6°C), bright LED.
 - c) Press selector switch AGAIN for Setting 3: Low Heat, 100°F (37.8°C), dim LED.
 - d) Press selector switch AGAIN: Heat function shuts off.
 - e) There is a small red indicator light, which illuminates only during the Heat function, in the selector switch. The light's brightness is determined by the Heat level being used:
Brightest = High Heat; Dimmest = Low Heat.
6. The Heat and Massage Unit automatically shuts off at the following times:
 - a) HEAT FUNCTION: After one hour of continuous use at the same level.
 - b) MASSAGE FUNCTION: After fifteen minutes of continuous use at the same level.
 - c) To restart the Heat and Massage Unit, follow previous steps 4 and 5.

Heat and Massage Unit Troubleshooting Guide

The cables and connections need to be validated. This will require the services of a maintenance person and a clear working area.

1. INSPECTION: Perform the following checks. If a working recliner of the same model is available, use it for comparison.
 - a) Is the AC cord properly connected to the power supply? Is the cable from the power supply to the control module junction box in place?
 - b) With the power supply AC cord plugged into a live AC outlet, does the small light to the left of the white seat symbol (located on the switch) light up when the switch is pressed repeatedly or is there any indication of massage operation?

⚠ WARNING: Disconnect the power cord from the AC outlet before performing the following steps!

- c) Is there any sign of external damage to the handheld pendant or wire?
 - d) Is there any sign of external damage to the recliner?
 - e) Do any of the cables show any sign of damage or pinch points?
 - f) Are all cable connections to the control module in place? Are the connectors fully engaged?
 - g) Are any of the connectors damaged?
 - h) Are the wires within the connectors attached to the pins? Each wire may have to be tugged lightly to check if the wire is still crimped to the pin.
2. POST-INSPECTION:
 - a) If improper or loose connections are found, reconnect them firmly (unless a loose wire has been found). Plug the power supply AC cord into a live wall socket and operate the unit through all functions.
 - b) If the handheld pendant or wire is damaged, notify Graham-Field so that a handheld pendant can be sent for replacement.
 - c) If damage to any other electrical cable or component, or disconnected wires are found, please notify Graham-Field.
 3. ACTIONS:
 - a) If full operation is restored, please advise Graham-Field of your successful outcome.
 - b) If the fault cannot be corrected by simple re-connection, please inform Graham-Field of the results of your inspection in detail so that we may determine the appropriate action to be taken.

If you have any questions about the setup and / or operation of the Heat and Massage Unit, call the Graham-Field Technical Support Group at 1.770.368.4700.

CARE AND MAINTENANCE

⚠ WARNING: Inspect all components periodically and replace as needed.

EVERY THREE MONTHS

- Check and clean casters.
- Tighten bolts in each leg that secure casters into frame.
- Check brakes on casters.
- Check and clean lock recline mechanism.
- Check recliner mechanism for operation in all positions, including Trendelenburg Position, with assistant seated in recliner.

UPHOLSTERY MAINTENANCE AND STAIN REMOVAL

- Ordinary dirt: wash with warm water and a mild soap or detergent.
- Stubborn dirt: using a soft bristle brush, wash with warm water and a mild soap or detergent.
- Ground-in dirt: scrub with powdered cleanser or similar detergent.
- Chewing gum: scrape carefully; remove with kerosene or naphtha.
- Nail polish and remover: Blot immediately to prevent damage.
- Ball point pen: blot immediately with a white cloth dampened in water or mineral oil.
- Paint, shoe polish, heel marks: remove immediately! Use a white cloth dampened in kerosene, naphtha or turpentine. Do not use paint remover or liquid brush cleaners.
- Tars, asphalt, creosote: remove to prevent staining. Clean area with kerosene or naphtha.

⚠ WARNING: When using kerosene or naphtha, do so in a well ventilated area and keep it away from fire, flame, and recliner occupant.

- Waxing and refinishing: improves wearability. Use any quality paste wax.
- A diluted solution of 10% (or less) of preferred store brand bleach or Clorox® may be used when cleaning this recliner.

PERMABLOK3® Care and Cleaning Guide — Advanced Vinyl Protection

- Step 1 (eye shadow, mascara, grease, black felt tip pen, crayon, chocolate, suntan lotion, hair and body oils): remove excess spill with a damp cloth. Clean with a 1:1 mix of Ivory® liquid soap and water. Next, rinse with clean water and dry.
- Step 2 (red lipstick): use a straight application of concentrated cleaners such as Formula 409® or Fantastik® spray cleaner. Wipe with a clean cloth, rinse with water, and dry.
- Step 3 (blood, urine, feces, oil base paint, tar, and asphalt): use a 1:1 mix of ammonia and water, or a 1:4 mix of bleach and water. Rinse with clean water and dry.
- Step 4 (all other tough stains): use a straight application of naphtha (lighter fluid). Rinse thoroughly with clean water and pat surface dry. If the stain persists, go to step 5.
- Step 5: use a 1:1 mix of isopropyl alcohol and water. If the stain persists, use straight alcohol. Rinse thoroughly with clean water and pat dry.

Info: For cleaning that requires step 4 or 5, use a soft cotton cloth saturated with the cleaning material and rub the stain in circles 10 times. Pat dry with another soft cotton cloth and check the results.

The information published in this care guide refers to the performance of PERMABLOK³ products in specific tests conducted under laboratory conditions. Results may vary under actual conditions.

This information is not a guarantee and does not relieve the user from the responsibility of the proper and safe use of the product and all cleaning agents. The use of certain agents can be harmful to the surface appearance and lifespan of vinyl. Spradling, its agents, and assigns assume no responsibility resulting from the use of such cleaning agents to the vinyl.

Please check compatibility when using this product in combination with painted or varnished surfaces.

PERMABLOK³ is a registered trademark of Spradling Holdings, Inc.

Ivory is a registered trademark of Procter & Gamble.

Formula 409 is a registered trademark of The Clorox Company.

Fantastik is a registered trademark of S.C. Johnson & Son, Inc.

Spradling International is not sponsored by, affiliated with, or endorsed by such trademark owners.

CDC RECOMMENDATIONS

CLEANING AND DISINFECTING STRATEGIES FOR ENVIRONMENTAL SURFACES IN PATIENT-CARE AREAS FOR VINYL UPHOLSTERY, WALL COVERINGS AND FLOORING

- Select EPA-registered disinfectants, if available, and use them in accordance with the manufacturer's instructions.
- Do not use high-level disinfectants / liquid chemical sterilants for disinfection of either noncritical instruments and devices or any environmental surfaces; such use is counter to label instructions for these toxic chemicals.
- Follow manufacturers' instructions for cleaning and maintaining noncritical medical equipment.
- In the absence of a manufacturer's cleaning instructions, follow certain procedures:
 - Clean noncritical medical equipment surfaces with a detergent / disinfectant.
 - Do not use alcohol to disinfect large environmental surfaces.
 - Use barrier protective coverings as appropriate for noncritical surfaces that are:
 - Touched frequently with gloved hands during the delivery of patient care.
 - Likely to become contaminated with blood or body substances.
 - Difficult to clean (e.g., computer keyboards).
- Keep housekeeping surfaces (e.g., floors, walls, tabletops) visibly clean on a regular basis and clean up spills promptly.
- Use a one-step process and an EPA-registered hospital detergent / disinfectant designed for general housekeeping purposes in patient-care areas where:
 - Uncertainty exists as to the nature of the soil on the surfaces (whether it is blood or body fluid or just normal dust or dirt).
 - Uncertainty exists regarding the presence of multi drug resistant organisms on such surfaces.

- Detergent and water are adequate for cleaning surfaces in nonpatient-care areas (e.g., administrative offices). Clean and disinfect high-touch surfaces on a more frequent schedule than minimal-touch housekeeping surfaces. Clean walls, blinds, and window curtains in patient-care areas when they are visibly dusty or soiled.
- Do not perform disinfectant fogging in patient-care areas.
- Avoid large-surface cleaning methods that produce mists or aerosols, or disperse dust in patient-care areas.
- Follow proper procedures for effective uses of mops, cloths, and solutions.
 - Prepare cleaning solutions daily or as needed, and replace with fresh solution frequently according to facility policies and procedures.
 - Change the mop head at the beginning of each day and also as required by facility policy, or after cleaning up large spills of blood or other body substances.
 - Clean mops and cloths after use and allow to dry before reuse; or use single-use, disposable mop heads and cloths.
- When performing low- or intermediate-level disinfection of environmental surfaces in nurseries and neonatal units, avoid unnecessary exposure of neonates to disinfectant residues on these surfaces by using EPA-registered germicides in accordance with manufacturers' instructions and safety advisories.

DISPOSAL AND KEY TO SYMBOLS

DISPOSAL

Lumex Recliner equipment and accessories can be disposed of.











We recommend disassembling and dividing the equipment and components into different waste groups such as: metal, cable, electronic, recoverable resource and plastic for recycling or combustion.

Most plastic components are provided with a plastic types code and fiber content to aid sorting of plastic parts.

Product	Metal Scrap	Cable Scrap	Electronic Scrap	Plastic Recycling or Combustion
FR577RG	X	X	N/A	X
FR577RGH	X	X	X	X
FR577RGHO	X	X	X	X

KEY TO SYMBOLS

The following symbols are used on Lumex Recliner product labels.

	MANUFACTURER		GENERAL WARNING SIGN
	FRAGILE, HANDLE WITH CARE		KEEP DRY
	CE MARK		ELECTRICAL AND ELECTRONIC EQUIPMENT
	CAUTION		CONSULT INSTRUCTIONS FOR USE
	EUROPEAN AUTHORIZED REPRESENTATIVE		MEDICAL DEVICE
	UNIQUE DEVICE IDENTIFIER		

CE CERTIFICATION (SERIES FR77RG ONLY)

Info: CE Certification applies ONLY to Series FR577RG Clinical Care Recliner.

CE Certification DOES NOT apply to Clinical Care Recliners with Heat and Massage (Series FR577RGH) or Clinical Care Recliners with Heat Only (Series FR577RGHO).



GF Health Products, Inc.

One Graham-Field Way, Atlanta, Georgia 30340-3140
Tel: 1.770.368.4700 Web: www.grahamfield.com



EC Authorized Representative
CEpartner4U BV, ESDOORNLAAN 13
3951 DB MAARN The Netherlands
+31 (0)6 516.536.26
www.cepartner4u.com



TECHNICAL SPECIFICATIONS

Overall Height	47" (119.4 cm)
Overall Width	31" (78.7 cm)
Overall Depth	35" (88.9 cm)
Width Between Arms	22" (55.9 cm)
Arm Height from Floor	25 1/2" (64.8 cm)
Arm Height from Seat	8" (20.3 cm)
Seat Height	22" (55.9 cm)
Seat Width	21 1/2" (54.6 cm)
Seat Depth	21" (53.3 cm)
Depth Fully Reclined in Trendelenburg	74" (188.0 cm)
Width with Both Side Tables in Upright Position	54" (137.2 cm)
Shipping Weight	127 lb (57.6 kg)
Maximum Weight Capacity	350 lb (158.76 kg), EVENLY DISTRIBUTED

For complete technical specifications, please call the Graham-Field Technical Support Group at 1.770.368.4700.

LIMITED WARRANTY

SCOPE OF WARRANTY

GF Health Products, Inc. (GF) warrants to the original purchaser only that it will replace or repair components, at GF's sole discretion, that are defective in material or workmanship under normal use and service. All warranties are conditioned upon the proper use of the products strictly in accordance with good commercial practice and applicable GF instructions and manuals, including proper use and maintenance. To the extent that a component is warranted by a third party, GF conveys all of its rights under that warranty to the original purchaser, to the extent permitted.

This limited warranty shall only apply to defects that are reported to the appropriate party listed in the **OBTAINING WARRANTY SERVICE** section that follows, within the applicable warranty period and which, upon examination by GF or its authorized representative, prove to be a warranty item. This limited warranty is not transferable.

Within the guidelines set forth in this document, the following components are warranted for the time period set forth below:

Steel Frame:.....ten (10) years
Mechanical Components:.....three (3) years
Heat and Massage Unit:.....two (2) years
Heat Only Unit:two (2) years
Casters:.....one (1) year
Upholstered Components:.....one (1) year
Replacement Parts:.....Ninety (90) Days

* Labor is not included in the warranty.

† Upholstery is only warranted on material supplied by GF.

‡ The warranty period is as designated above. If a part is replaced under warranty, the original warranty period will not be affected. All other replacement parts will be subject to the warranty period specified.

The applicable warranty period shall commence from date of shipment to the original customer, unless there is an expiration date on the component in which case the warranty shall expire on the earlier of warranty period or the expiration date.

OBTAINING WARRANTY SERVICE

Customers located in the United States who wish to report a warranty issue, must contact GF directly by calling 1.770.368.4700 or by e-mailing a request to cs@grahamfield.com.

Customers located outside the United States who wish to report a warranty issue, must contact the Distributor from whom they purchased the products.

In both cases, further directions will be provided once the initial contact is made. This limited warranty shall only apply to defects that are reported within the applicable warranty period. Failure to abide by the specific directions will result in denial of the warranty claim.

EXCLUSIONS

The warranty does not cover and GF shall not be liable for the following:

1. Defects, damage, or other conditions caused, in whole or in part, by misuse, abuse, negligence, alteration, accident, freight damage, tampering or failure to seek and obtain repair or replacement in a timely manner;
2. Products which are not installed, used, or properly cleaned and maintained as required in the official manual for the applicable product;
3. Products considered to be of a non-durable nature including, but not limited to: filters, fuses, gaskets, lubricants, and charts;
4. Accessories or parts not provided by GF;
5. Matching of color, grain or texture except to commercially acceptable standards;
6. Changes in color caused by natural or artificial light;
7. Charges by anyone for adjustments, repairs, replacement parts, installation or other work performed upon or in connection with such products which are not expressly authorized in writing, in advance, by GF;
8. Any labor or shipping charges incurred in the replacement part installation or repair;
9. Costs and expenses of regular maintenance and cleaning; and
10. Representations and warranties made by any person or entity other than GF.

ENTIRE WARRANTY, EXCLUSIVE REMEDY AND CONSEQUENTIAL DAMAGES DISCLAIMER

THIS WARRANTY IS GF'S ONLY WARRANTY AND IS IN LIEU OF ALL OTHER WARRANTIES, EXPRESS OR IMPLIED. GF MAKES NO IMPLIED WARRANTIES OF ANY KIND INCLUDING ANY IMPLIED WARRANTIES OF MERCHANTABILITY OR FITNESS FOR A PARTICULAR PURPOSE. IF ANY MODEL OR SAMPLE WAS SHOWN TO THE CUSTOMER, SUCH MODEL OR SAMPLE WAS USED MERELY TO ILLUSTRATE THE GENERAL TYPE AND QUALITY OF THE PRODUCT AND NOT TO REPRESENT THAT THE PRODUCT WOULD NECESSARILY CONFORM TO THE MODEL OR SAMPLE IN ALL RESPECTS. THIS WARRANTY IS LIMITED TO THE REPAIR OR REPLACEMENT OF THE DEFECTIVE PARTS. GF SHALL NOT BE LIABLE FOR AND HEREBY DISCLAIMS ANY DIRECT, SPECIAL, INDIRECT, INCIDENTAL, EXEMPLARY OR CONSEQUENTIAL DAMAGES, INCLUDING, BUT NOT LIMITED TO: DAMAGES FOR LOSS OF PROFITS OR INCOME, LOSS OF USE, DOWNTIME, COVER, OR EMPLOYEE OR INDEPENDENT CONTRACTOR WAGES, PAYMENTS AND BENEFITS. CERTAIN STATES MAY CONFER ADDITIONAL RIGHTS REGARDING WARRANTIES AND IN THOSE STATES GF'S LIABILITY AND THE LIABILITY OF GF'S SUPPLIERS, SHALL BE LIMITED TO THE FULLEST EXTENT PERMITTED BY LAW.

The warranties contained herein, together with GF's current Terms and Conditions, contain all the representations and warranties with respect to the subject matter of this document, and supersede all prior negotiations, agreements and understandings with respect thereto. The recipient of this document hereby acknowledges and represents that it has not relied on any representation, assertion, guarantee, warranty, collateral contract or other assurance, except those set out in this document.

For additional information on this product or this warranty, please contact a GF Customer Service Representative.

NOTES:

- 1) Additional terms and conditions may apply. See GF's General Terms and Conditions on its website: www.grahamfield.com.
- 2) Freight claims must be notated on the appropriate shipping documents and must be made with immediacy. International, federal and state regulations govern specific requirements for freight claims. Failure to abide by those regulations may result in a denial of the freight claim. GF will assist you in filing the freight claim.
- 3) Claims for any short shipment must be made within three (3) days of the invoice date.

INDEX

A

Assembly 5

C

Cable tension, adjusting 11

Care and maintenance 18

Caster, directional (swivel) 8

Caster, locking 8

Caster operation 8

CAUTION statement, significance 3

CE Certification 21

D

Disposal 20

G

Gas spring troubleshooting guide 11

H

Heat and massage components 12

Heat and massage connection 12

Heat and massage description 12

Heat and massage feature 12

Heat and massage installation and operating guide 12

Heat and massage operation Instructions, Gen 3 15

Heat and massage troubleshooting guide 17

I

Important safety precautions 3

Info statement, significance 3

Intended use 3

Introduction 3

K

Key to symbols 21

L

Limited warranty 22

N

NOTICE statement, significance 3

O

Operation 8

P

Product description 5

R

Recliner operation 9

S

Side panel, install 9

Side panel operation 9

Side panel, remove 9

Side table, lower 8

Side table operation 8

Side table, raise 8

Symbol key 21

T

Technical specifications 21

Trendelenburg (shock) position 10

U

Upholstered back assembly 5

Upholstery maintenance and stain removal 18

W

WARNINGS 3

WARNING statement, significance 3

Warranty, limited 22

LUMEX[®]

by graham-field

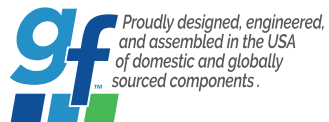

Manufactured By:
GF Health Products, Inc.
1 Graham-Field Way, Atlanta, GA 30340
Made in USA



+1 770.368.4700

Information contained herein is subject to change without notice.
The most current and complete product information can be found on our website.
www.grahamfield.com



© 2012, GF Health Products, Inc. All Rights Reserved.
Lumex is a registered trademark of GF Health Products, Inc.

LX_FR577RG-INS-LAB-RevL24