



**STS500 / STS500M
SIT-TO-STAND PATIENT LIFT
USER MANUAL**

SAVE THIS MANUAL FOR FUTURE USE.

CONTENTS

1	INTRODUCTION.....	3
2	SAFETY PRECAUTIONS.....	4
	WARNINGS.....	4
3	FEATURES.....	6
	STS500 / STS500M SIT-TO-STAND FEATURES.....	6
	CONTROL BOX COMPONENTS	6
4	HANDLING PROCEDURES.....	7
	SHIPPING AND TRANSPORTATION INSTRUCTIONS.....	7
5	SETUP	8
	ASSEMBLY INSTRUCTIONS	8
6	USER GUIDE.....	9
	CHARGING THE BATTERY	9
	OPERATING INSTRUCTIONS — USING THE CONTROL BOX.....	10
	OPERATING INSTRUCTIONS — USING THE PENDANT	11
	LIFT PREPARATION AND PROCEDURE.....	12
	LIFTING THE PATIENT.....	13
	EMERGENCY LOWERING DEVICE	16
7	CARE AND MAINTENANCE.....	17
	BEFORE EACH USE	17
	AT LEAST ONCE A MONTH	17
	LUBRICATION	17
	CLEANING.....	18
	CARE OF SLINGS	18
	MAINTENANCE SCHEDULE	18
8	TROUBLESHOOTING.....	19
9	SPECIFICATIONS	20
10	LIMITED WARRANTY	21
11	INDEX	23



1 INTRODUCTION

Congratulations on your purchase of the Lumex STS500 / STS500M Sit-to-Stand Patient Lift. The following pages will provide you with important safety and operating instructions on the use of patient lifts, slings, and accessories, as well as maintenance and warranty information. Read this manual carefully before operating your patient lift and refer to it as often as needed. Consult your authorized distributor and / or healthcare professional with any questions or concerns regarding safe and effective techniques for operating your patient lift.

DO NOT attempt any transfer without prior approval of the patient's healthcare provider. With their assistance, select the sling that best serves the needs, abilities, comfort and safety of the person being lifted. It is important that you use correct slings adapted to the body shape and weight and ability of the patient and the specific type of transfer needed.

Upon receipt of the patient lift, and prior to each use, inspect it closely to ensure that nothing is damaged, there are no loose or broken parts, that all patient lift parts are in the proper place, etc. Immediately replace any worn or broken components. Your patient lift should receive maintenance on a regular schedule and should be inspected daily for proper operation. Contact GF Health Products, Inc. ("GF") Tech Support at 1.770.368.4700 with any maintenance concerns.

Before lifting anyone, thoroughly read the instructions in this manual. Ideally, observe a team of trained experts performing the lifting procedures. The operator should then practice the entire lifting procedure several times with proper supervision and with a capable individual acting as patient. It is extremely important to know how a patient will feel in the patient lift. We suggest that the operator try all the various lifting slings and equipment until the operator is confident with how the patient lift operates. The lifting procedures should be explained to the patient before the actual lifting. Remember that safety requires the constant attention of the lift occupant and the operator. Use extreme care and common sense when operating a patient lift.

This guide covers the use of the Lumex STS500 / STS500M Sit-to-Stand Patient Lift. Keep in mind that the basic safety procedures included in this manual are to be used as a guide only. You may find it necessary to develop your own unique methods for safely utilizing the patient lift. Again, consult your healthcare professionals for their recommendations and never hesitate to ask for their assistance.

Info: Before attempting to assemble the patient lift, refer to the section titled "ASSEMBLY INSTRUCTIONS" contained elsewhere in this manual. Contact GF Tech Support at 1.770.368.4700 or your GF authorized distributor if additional assistance is needed.

Info: In this manual, the person being lifted is referred to as the "patient" or "occupant" and the person operating the patient lift is called the "operator" or "attendant".

Intended use

The Lumex STS500 / STS500M Sit-to-Stand Patient Lift is intended to aid in the transfer of an individual who is unable to independently transfer between bed, chair, bathtub, wheelchair, and / or commode.

- ⚠ WARNING: The Lumex STS500 / STS500M Sit-to-Stand Patient Lift is designed for transfer only (to and from bed, chair, bathtub, toilet, wheelchair, commode etc.). This Patient Lift is not intended to be used for transporting or moving a patient from one location to another.**
- ⚠ WARNING: The Lumex STS500 / STS500M Sit-to-Stand Patient Lift is designed for use by individuals who can support the majority of their own weight. Special care must be taken with patients who cannot provide assistance while being lifted (i.e. such as patients who are comatose, spastic, agitated or otherwise severely disabled).**

2 SAFETY PRECAUTIONS

IMPORTANT: Before using patient lift, read and adhere to the following safety precautions and warnings. Failure to do so could result in serious personal injury or damage to your patient lift.

Always consult your healthcare professional to determine safe methods most suitable for your individual abilities. Protect yourself, your attendant and patient lift by having it serviced regularly. If you experience any malfunction, contact GF Tech Support at 1.770.368.4700 or your GF authorized distributor immediately, as a hazardous condition could result, causing personal injury or damage to your patient lift.

Periodic inspection, adjustment and replacement of worn parts are necessary to provide years of excellent service. Refer to *CARE AND MAINTENANCE* section of this manual.

Maintenance **MUST** be performed by qualified personnel **ONLY**.

Significance of safety statements

Note the following special statements, used throughout this manual, and their significance:

- ⚠ WARNING:** Indicates a potential hazard situation or unsafe practice that, if not avoided, could result in death or serious personal injury.
- ⚠ CAUTION:** Indicates a potential hazard situation or unsafe practice that, if not avoided, could result in minor or moderate personal injury.
- ▲ NOTICE:** Indicates a potential hazard situation or unsafe practice that, if not avoided, could result in product or property damage.

Info: Provides application recommendations or other useful information to ensure that you get the most from your product.

WARNINGS

- ⚠ WARNING:** Important! Read and understand these instructions before assembling or using the Lumex STS500 / STS500M Sit-to-Stand Patient Lift. If you do not understand any part of these warnings, cautions or instructions, contact a healthcare professional for direction in the use of this product. If the Lumex STS500 / STS500M Sit-to-Stand Patient Lift is not properly assembled, personal injury and damage to the STS500 / STS500M could result.
- ⚠ WARNING:** If components are damaged or missing, contact your GF authorized distributor immediately. **DO NOT** use substitute parts. Use only Lumex replacement parts. The use of non-Lumex replacement parts could cause personal injury, property damage, and void the warranty.
- ⚠ WARNING:** Unauthorized modification of your patient lift could cause personal injury, property damage, and void the warranty.
- ⚠ WARNING:** The Lumex STS500 / STS500M Sit-to-Stand Patient Lift maximum weight capacity is 500 lb (226 kg), **EVENLY DISTRIBUTED**. **DO NOT** exceed the maximum weight capacity.
- ⚠ WARNING:** GF Health Products, Inc. assumes no responsibility for any damage or injury caused by improper assembly or use of this product.
- ⚠ WARNING:** Check all parts for shipping damage before using. In case of damage, **DO NOT USE** the equipment. Contact the carrier or your GF authorized distributor for further instructions.

- ⚠ WARNING: Patient lift may tip over if used incorrectly. Read and adhere to the operating instructions prior to lifting anyone.**
- ⚠ WARNING: Although Graham-Field recommends that two assistants perform any lifting preparation or transfer procedure, our equipment will permit proper operation by one assistant. The use of one assistant is based on the evaluation of the healthcare professional for each individual case.**
- ⚠ WARNING: When transferring a patient, always keep the patient centered over the base.**
- ⚠ WARNING: Ensure that lifting sling loops are correctly attached to the hooks to prevent the patient from sliding or falling out of the sling, which could result in personal injury. Never use the patient lift to lift or transfer anything other than a person.**
- ⚠ WARNING: Do not lock the brakes or block the wheels when lifting. The casters must be FREE to roll to allow the patient lift to stabilize itself when the patient is initially lifted from a chair, bed, or any stationary object.**
- ⚠ WARNING: Do not roll casters over any object while the user is in the sling.**
- ⚠ WARNING: Do not attempt to maneuver the lift by pushing on the mast, boom, actuator, or patient. Always maneuver the lift with the handle.**
- ⚠ WARNING: During lifting or lowering, whenever possible, always keep the patient lift legs in the maximum open position.**
- ⚠ WARNING: To facilitate movement, close patient lift legs before moving the lift.**
- ⚠ WARNING: Replace any worn or broken parts immediately! Torn, cut, frayed, or broken slings can fail, resulting in serious personal injury. Use only slings that are in good condition.**
- ⚠ WARNING: Use extreme care, caution, and common sense when utilizing a patient lift. Special attention must be given to patients who are disoriented and cannot cooperate while being lifted, such as comatose, agitated, spastic, or mentally confused persons. Consult their healthcare professional for assistance in lifting these types of patients.**
- ⚠ WARNING: The electronics and actuator contain no serviceable components. If service is required, the unit must be returned to the factory for repair. DO NOT attempt to open the electronics or actuator. If service is required, consult GF Tech Support at 1.770.368.4700 for further information.**
- ⚠ WARNING: GF Health Products, Inc. specifically disclaims responsibility for any bodily injury or property damage which may occur during any use which does not comply with federal, state or local laws or ordinances.**

3 FEATURES

STS500 / STS500M SIT-TO-STAND FEATURES



CONTROL BOX COMPONENTS

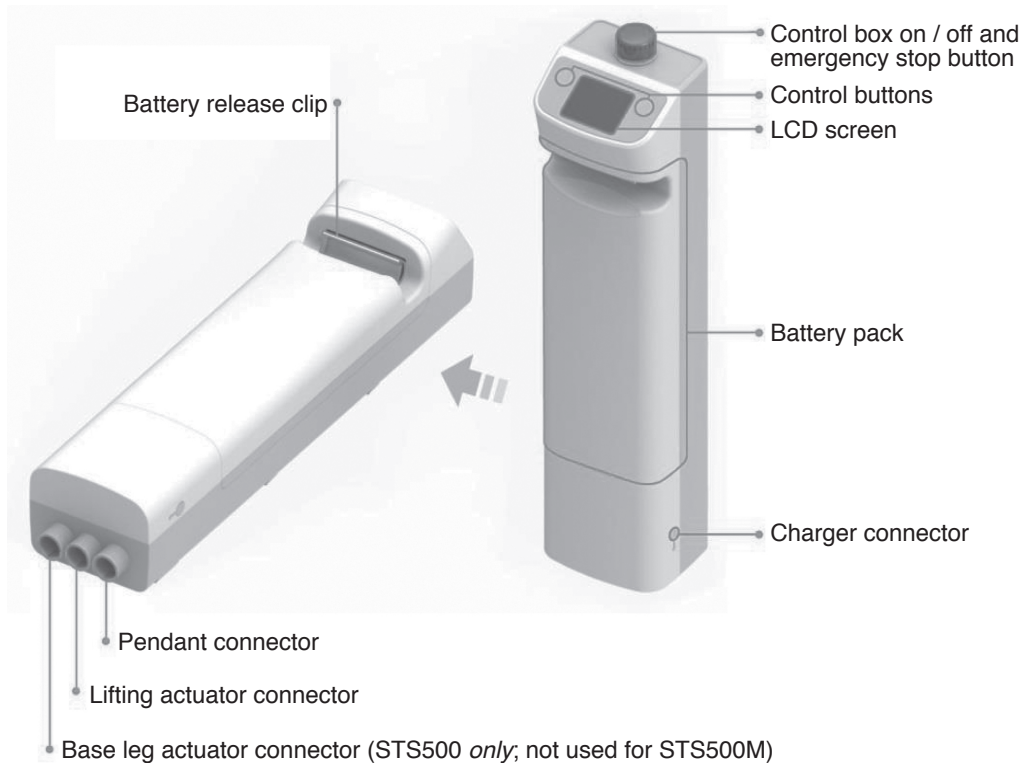

▲ **NOTICE: DO Not operate the lift while it is charging.**

4 HANDLING PROCEDURES

SHIPPING AND TRANSPORTATION INSTRUCTIONS

If the patient lift is to be reshipped by common carrier, it should be packed in the same carton in which it was received.

Unpacking

⚠ WARNING: The lift is heavy. To avoid personal injury, DO NOT attempt to remove the lift from the box without assistance.

1. Check for any obvious damage to the carton or its contents. If damage is evident, notify the carrier or your GF authorized distributor.
2. Remove all loose packing from the carton.
3. Carefully remove all the components from the carton.

Info: Unless the patient lift is to be used immediately, retain boxes, containers and packing material for use in storing until use of patient lift is required.

Inspection

1. Examine the exterior of the patient lift for nicks, dents, scratches or other damage.
2. Inspect all components.

Storage

1. Store the repackaged patient lift in a dry area.
2. DO NOT place other objects on top of the repackaged patient lift.

▲ NOTICE: DO Not operate the lift while it is charging.

5 SETUP

ASSEMBLY INSTRUCTIONS

⚠ WARNING: The lift is heavy. To avoid personal injury, DO NOT attempt to assemble the lift without assistance.

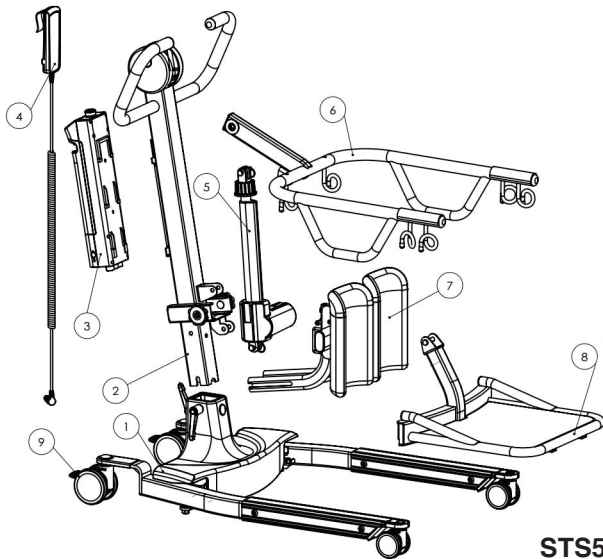

STS500

Item	Component
------	-----------

1	Base
2	Mast
3	Control Box
4	Pendant
5	Actuator
6	Lifting Boom
7	Kneepad Assembly
8	Footrest
9	Brake

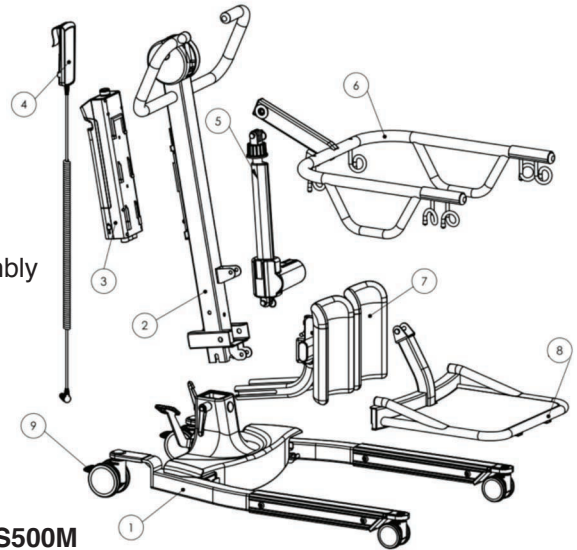

STS500M

1. Remove the nuts and bolts from top and bottom of mast.
2. Insert mast into base
3. Reinstall bolts in holes at bottom of mast and hand tighten them.
4. Attach lifting boom and actuator to mast, and tighten bolt and nuts.
5. Attach L-shaped arms to back of knee pad.
6. Attach footrest to mast and base.
7. Attach knee pad assembly to mast.
8. Attach control box to mast.
9. Plug lifting actuator plug into control box at location shown on the bottom of page 6.
10. Plug pendant plug into control box at location shown on the bottom of page 6.
11. **STS500 only:** Plug base leg actuator plug into control box at location shown on the bottom of page 6.
12. Tighten all nuts.

⚠ WARNING: Before using Patient Lift, ensure that lift is assembled as described, that all attaching hardware is securely tightened, and that all lift components are secure.

Info: Before using the lift, charge the battery until the pendant lights stop flashing (see CHARGING THE BATTERY instructions on following page).

6 USER GUIDE

CHARGING THE BATTERY

The lift battery can be charged by plugging the charger directly into the control box while it is attached to the lift,

Or

The battery pack can be charged in the wall / desk charging caddy.

Info: The lift battery will be partially charged when it is new, but your new lift battery should be fully charged (until the pendant lights stop flashing) before use.

Charging the Battery in the Lift

The lift battery can be charged with the battery pack in place. Plug the charging cable into the side of the control box (the control box holds the battery pack and PC board).

Info: Place the red button on top of the control box in the UP position while charging.

- When the battery indicator shows a full black bar and the pendant shows 3 green nonflashing lights, battery is fully charged.
- When the pendant shows 2 green flashing lights, battery will take 4 hours to fully recharge.
- When the pendant shows 1 green flashing light, battery will take 6 hours to fully recharge.
- When the pendant shows 1 orange flashing light, battery will take 8 hours to fully recharge.
- When the battery is fully charged, the pendant lights will stop flashing.

Info: When the battery is fully charged, place the red button on top of the control box in the DOWN position to prevent the battery from draining.

Charging the Battery in the Caddy

The battery can also be charged in the wall / desk charging caddy. Squeeze the lever to release the battery pack and seat it in the caddy. Plug the charger into the side of the caddy.

- If you are charging in the caddy, when the charger is plugged in, the caddy light will be green.
- The charger light will be green if the battery is more than 80% charged.
- The charger light will be orange if the battery is less than 80% charged.

Info: The STS500 / STS500M comes with a spare battery pack. For convenience, keep the spare battery fully charged.

OPERATING INSTRUCTIONS – USING THE CONTROL BOX

▲ **NOTICE: DO Not operate the lift while it is charging.**

1. If you press either Control Button (shown at right) for less than 0.5 seconds, you can access the screens shown below:

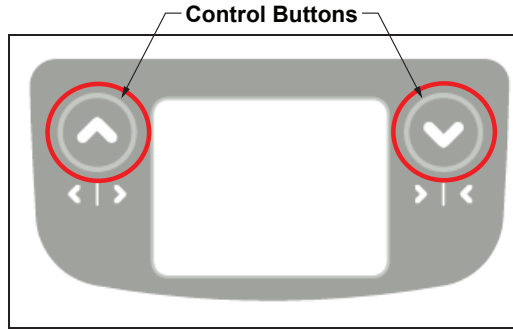

<ul style="list-style-type: none"> • Raise or lower the lift 	<ul style="list-style-type: none"> • Adjust the distance between the lift legs 	<ul style="list-style-type: none"> • Remaining battery capacity
---	---	--

2.

<p>Left button</p> <p>Pressing the left button for more than 0.5 seconds will begin actuator extension.</p>		<p>Right button</p> <p>Pressing the right button for more than 0.5 seconds will begin actuator retraction.</p>
--	--	---

3. Press the button to raise or the button to lower the lift.

<p>Raise / Lower Lift</p>	<p>Long press to raise lift </p>	
	<p>Long press to lower lift </p>	

4. **STS500:** Press the button to open or the button to close the lift base legs.
STS500M: Use the foot pedal to open or close the lift base legs.

<p>Open / Close Base Legs</p>	<p>Long press to close base legs </p>	
	<p>Long press to open base legs </p>	

OPERATING INSTRUCTIONS – USING THE PENDANT

▲ **NOTICE:** DO Not operate the lift while it is charging.

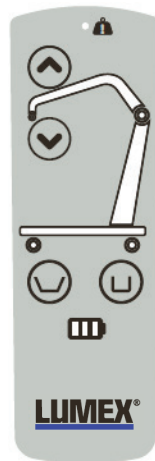

Raise / Lower Lift		
	Long press to raise lift	
	Long press to lower lift	

1. Press the button to raise or the button to lower the lift.

Open / Close Base Legs		
	Long press to close base legs	
	Long press to open base legs	

2. **STS500:** Press the button to open or the button to close the lift base legs.
STS500M: Use the foot pedal to open or close the lift base legs.

LIFT PREPARATION AND PROCEDURE

- ⚠ **WARNING:** During lifting and lowering, whenever possible, always keep the base legs of the lift in the widest position.
- ⚠ **WARNING:** Use only Lumex slings specially designed for the Lumex STS500 / STS500M Sit-to-Stand Patient Lift.
- ⚠ **WARNING:** Do not put anything (e.g. cushion, pad, etc.) between the user and the sling. This may cause user to slide out of the sling and could cause injury.
- ⚠ **WARNING:** Although Graham-Field recommends that two assistants perform any lifting preparation or transfer procedure, our equipment will permit proper operation by one assistant. The use of one assistant is based on the evaluation of the healthcare professional for each individual case.

Info: Instructional videos that review the application of several sling styles and lifting scenarios are available at www.grahamfield.com.

Info: While transferring a patient, the patient lift legs can be in either open or closed position.

Preparation before lifting

1. Turn on the power.
2. Ensure the battery is charged.
3. Press the pendant UP or DOWN button once.
4. Push the pendant UP button and DOWN button to ensure the lift is operating correctly.
5. Position the lift base around or under the patient.
6. Widen the base.

Fitting Lumex Sit-to-Stand Sling

- ⚠ **WARNING:** The Lumex Sit-to-Stand sling is not suitable for patients who have involuntary movements, or patients with limited postural control.
- ⚠ **WARNING:** Ensure the sling you are using has adequate weight capacity for the person you are lifting.

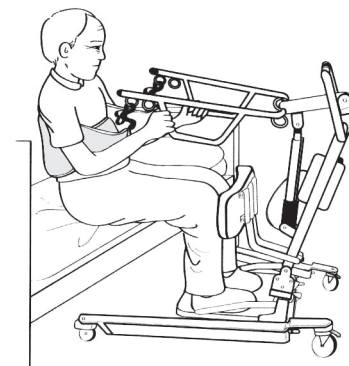
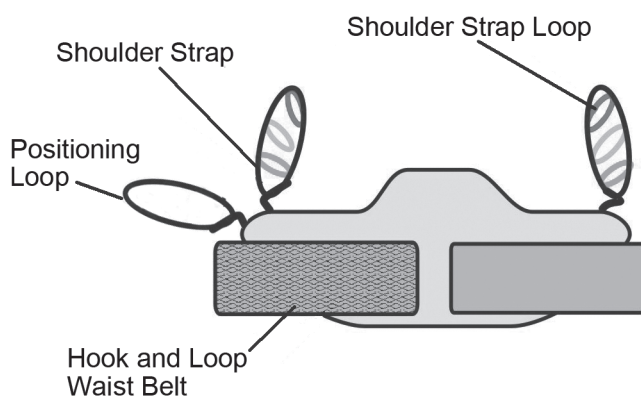

1. Position the patient in a sitting position.
2. Slide the sling down patient's back to lumbar position.
3. Draw the shoulder straps to the front of the patient close to the chest.
4. Draw the waist belt around patient's waist and press hook and loop sections together to fasten.
5. Place shoulder straps inside the positioning loop.
6. Attach the shoulder straps to the hooks.

LIFTING THE PATIENT

- ⚠ **WARNING:** Do not attempt to transfer a patient without prior approval of the patient's healthcare professional and without having read the instructions and practiced using the patient lift.
- ⚠ **WARNING:** Use special care for those patients who cannot cooperate while being lifted.
- ⚠ **WARNING:** Ensure all bolts, hooks, and loops are securely fastened.
- ⚠ **WARNING:** Use only Lumex slings with the Lumex STS500 / STS500M Sit-to-Stand Patient Lift.
- ⚠ **WARNING:** DO NOT use torn, cut, frayed or broken slings as injury could result.
- ⚠ **WARNING:** Ensure the floor area is clear of any obstacle that could cause a caster to stop and possibly tip the patient lift.

Lift and transfer from bed

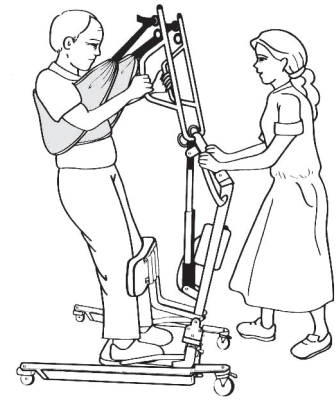
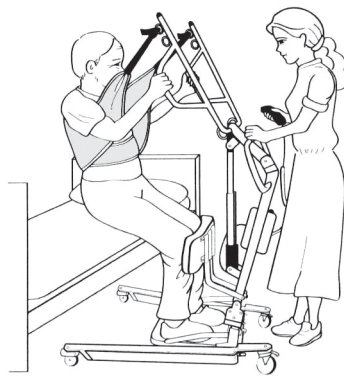
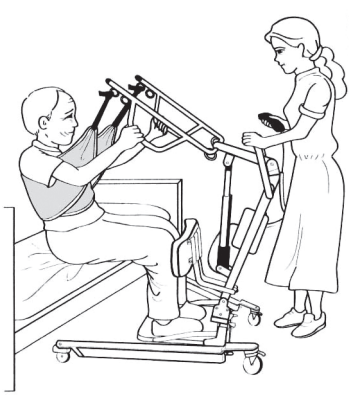

⚠ WARNING: Do not lock or block the patient lift casters when lifting. The casters must be free to roll so that the patient lift can stabilize as the patient is lifted from the bed.

⚠ WARNING: To ensure stability while lifting or lowering a patient, the patient lift legs should be in the maximum open position.

1. Fit sling as described in "Fitting Lumex Sit-To-Stand Sling".
2. Push lift towards patient. Open the base of the lift. Apply the brakes on both rear casters.
3. Position patient's feet on the foot platform and knees against the kneepad.
4. Attach the sling straps to the hooks.
5. Have the patient's hands holding the handles. For patients who cannot hold the handles, have them hold their arms around the chest.
6. Press the pendant "UP" button.
7. Before the patient's body is lifted from the bed, stop and make sure the sling is secured and patient's knees are against the kneepad.
8. The patient should be comfortable with the pressure under the arms. If not, adjust the sling and try another loop option to release pressure.
9. Press the "UP" button until the patient's body has completely left the bed.
10. Transfer to another object can be done at this position without the patient attending a full standing position.
11. Release the brakes, close the base, and pull the lift away from the bed.
12. Lower the patient to the object intended.
13. To lift patient in a standing position, continue to lift until the patient's knees are locked in a standing position.
14. At the standing position, patient's knees may move away from the kneepad.
15. Close the base, and pull the lift away from the bed.
16. Lower the patient to the object intended.
17. Reverse the above procedures when lowering the patient to the bed.

Lift and transfer from chair



⚠ WARNING: GF Health Products, Inc. recommends that two attendants be used when transferring a patient to and from a wheelchair.

⚠ WARNING: Before transfer, ensure wheelchair wheel locks are in locked position. Wheelchair wheel locks must be in LOCKED POSITION before lowering the patient into the wheelchair, or unexpected wheelchair movement could result, which may result in serious injury to both the patient and the attendants.

1. Fit sling as described in "Fitting Lumex Sit-To-Stand Sling".
2. Push lift towards patient. Open the base of the lift to go around the chair. Apply the brakes on both rear casters.
3. Position patient's feet on the foot platform and knees against the kneepad.
4. Attached the sling straps to the hooks.
5. Have the patient's hands holding the handles. For patients who cannot hold the handles, have them hold their arms around the chest.
6. Press the "UP" button on the hand control.
7. Before the patient's body is lifted from the chair, stop and make sure the sling is secured and patient's knees are against the kneepad.
8. The patient should be comfortable with the pressure under the arms. If not, adjust the sling and try another loop option to release pressure.
9. Press the "UP" button until the patient's body has completely left the chair.
10. Transfer to another object can be done at this position without the patient attending a full standing position.
11. Release the brakes, close the base, and pull the lift away from the chair.
12. Lower the patient to the object intended.
13. To lift patient in a standing position, continue to lift until the patient's knees are locked in a standing position.
14. At the standing position, patient's knees may move away from the kneepad.
15. Release the brakes, close the base, and pull the lift away from the chair.
16. Lower the patient to the object intended.
17. Reverse the above procedures when lowering the patient to the chair.

EMERGENCY LOWERING DEVICE

In case of power failure while using the Lumex STS500 / STS500M Sit-to-Stand Patient Lift, follow the procedure below to safely lower the user. The Emergency Lowering Device is located at the top of the actuator shaft. ***It is intended for use if the actuator fails to operate while a patient is suspended.***

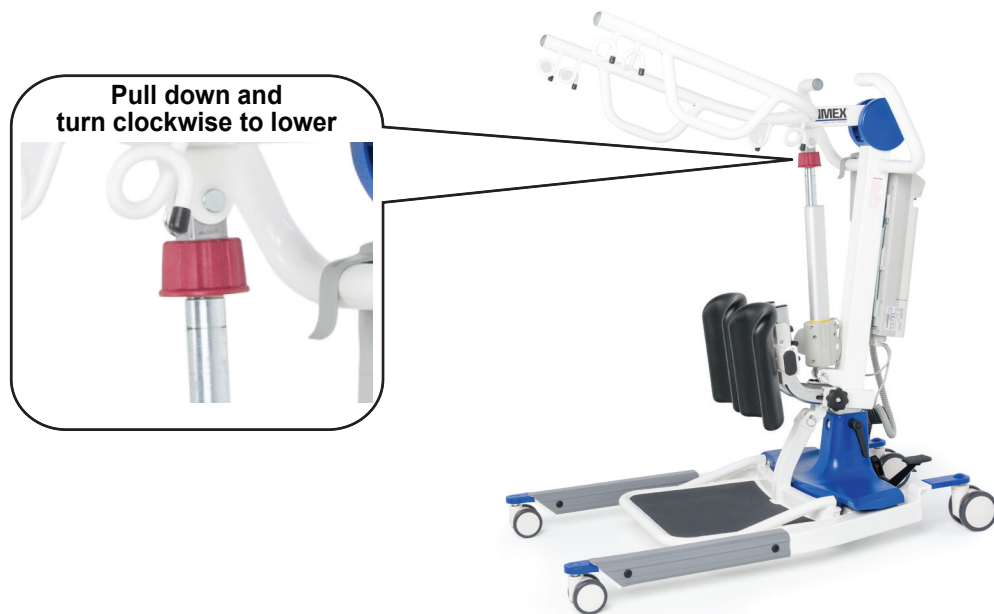

The emergency lowering device, shown above, consists of a plastic collar ring that should be pulled down, then turned clockwise continually until the patient has been lowered.

⚠ WARNING: Contact your dealer immediately if standard troubleshooting techniques do not correct the failure. Do not attempt to lift patients until all failure issues have been safely resolved.

Info: The emergency lowering device is intended for use during lift failure. This device will allow lowering of patients only. Contact GF Tech Support at 1.770.368.4700 or your GF authorized distributor immediately in case of failure.

7 CARE AND MAINTENANCE

Proper care and maintenance are essential to keeping your Lumex STS500 / STS500M Sit-to-Stand Patient Lift in a safe operating condition. In addition to inspecting the unit before each use, periodic maintenance checks should be done.

- ⚠ WARNING: It is extremely important that the patient lift be inspected before each use. Ensure that all hardware and accessories are secure and that the actuator is functioning properly. Failure to do so could result in patient / attendant injury or damage to your patient lift. Torn, cut, frayed or broken slings can fail, resulting in serious injury. Only use slings in good condition. Inspect before each use. Destroy and discard old worn and unusable slings.**
- ⚠ WARNING: Service and repair of the Lumex STS500 / STS500M Sit-to-Stand Patient Lift MUST be performed by qualified personnel ONLY.**
- ⚠ WARNING: Unauthorized modification of the patient lift or the use of non-Lumex replacement parts may change the structure of the lift and could create a hazardous condition, which may result in serious injury and may void the warranty.**
- ⚠ WARNING: The electronics and actuator contain no serviceable components. DO NOT attempt to open the electronics or actuator. If service is required, consult GF Tech Support at 1.770.368.4700 for further information.**

When you believe a component or part is not functioning properly, immediately contact GF Tech Support at 1.770.368.4700, as a potentially hazardous condition could exist.

BEFORE EACH USE

Before each use of the patient lift, ensure that:

- All nuts and bolts are tight
- The base can be easily widened
- All lift parts are in place
- All casters turn freely
- Caster brakes can be engaged
- All necessary items (i.e. slings, wheelchairs, etc.) are accessible and ready for use
- Battery capacity is adequate

AT LEAST ONCE A MONTH

The lift should be thoroughly inspected by a person qualified to recognize any signs of wear, and looseness of bolts or parts. Replace any worn parts immediately.

LUBRICATION

When the lift is serviced, and every month thereafter, place a drop of lubricant (White Lithium Grease is recommended) on the following points:

- The point where mast and boom connect
- Caster axles
- The point where actuator and boom connect

CLEANING

Regular cleaning is recommended every three months; clean the lift more often as needed. A soft cloth, dampened with water and a mild NON-ABRASIVE detergent (household cleaner, soapy water, or hospital grade disinfectant) is all that is needed to clean your patient lift. Automobile wax or furniture polish will help maintain the finish over a long period of time.

▲ **NOTICE: DO NOT wash patient lift under water pressure or steam clean.**

CARE OF SLINGS

Lumex slings are washable at 120°F or lower. If there is a removable plastic insert in the head support, remove insert before washing. Air dry or dry at temperature less than 120°F.

▲ **NOTICE: DO NOT bleach slings!**

MAINTENANCE SCHEDULE





Info: Only qualified persons should service and repair your Lumex STS500 / STS500M Sit-to-Stand Patient Lift. Regular maintenance of your patient lift is necessary to ensure continuing proper and safe operation. Read and observe the following recommended maintenance schedule:

ITEM	INSPECT	INSPECT / ADJUST	
	INITIALLY	MONTHLY	EVERY 3 MONTHS
BOOM & SPREADER BAR			
Check connections between 1) boom and spreader bar and 2) boom and mast for improper connection, looseness, or wear	X	X	
Inspect boom for bending or deflection	X	X	
MAST			
Inspect mast for bending or deflection	X	X	
Inspect steering bar for damage or loose hardware	X	X	
BASE			
Ensure all hardware is tight	X	X	
Ensure casters and axle bolts are tight	X	X	
Inspect rubber parts of casters for deflection	X		X
Apply grease to caster ball bearings if needed			X
ACTUATOR AND CONTROL BOX			
Ensure control box is firmly affixed to the mast	X	X	
Ensure pins that connect actuator to boom and mast are firmly affixed	X	X	
Ensure cables that connect actuators and control box are firmly affixed	X	X	
Ensure battery indicator has at least 2 green LEDs illuminated before use	X	X	
SLING AND SLING HARDWARE			
Check sling for wear; discard if worn	X	X	
Ensure sling hardware is in good condition before each use	X	X	

8 TROUBLESHOOTING

The following list of encountered problems and their solutions will assist you in determining what may be causing your Lumex lift not to function as designed. If you have a problem occurring which is not listed below, contact GF Tech Support at 1.770.368.4700 for further information. Do not attempt to repair components or parts on your lift, as this may invalidate your warranty or cause further problems that may result in patient injury. Stop using your lift immediately if it is not functioning correctly or any warning beeps are heard.

If any of the following notifications occurs, follow the steps below to troubleshoot:

<p>Maintenance Notification: Check the state of the lift and actuators.</p>	<p style="text-align: center;">ATTENTION</p> <div style="text-align: center;">  <p>Maintenance Required</p> </div>
<p>Low Battery Capacity: Recharge battery. If it does not hold a proper charge, the battery will need to be replaced.</p>	<p style="text-align: center;">ATTENTION</p> <div style="text-align: center;">  <p>Recharge Or Exchange</p> </div>
<p>Overload Alarm: Weight has exceeded the set maximum limit. Remove weight from the lift and retry.</p>	<p style="text-align: center;">ATTENTION</p> <div style="text-align: center;">  <p>Overloaded</p> </div>
<p>Upper Limit Switch Failed: Actuator failure. Discontinue use of lift immediately. Contact GF Tech Support at 1.770.368.4700 or your GF authorized distributor.</p>	<p style="text-align: center;">ATTENTION</p> <div style="text-align: center;">  <p>Upper Limit Switch Failed</p> </div>
<p>Force Interference: If any force interferes when the lift is lowered, the lift will stop working to avoid injury to the patient. Remove interference immediately. This image will also appear if the actuator connectors are installed in the wrong positions in the control box. See page 6.</p>	<p style="text-align: center;">ATTENTION</p> <div style="text-align: center;">  <p>Please Check Hoist</p> </div>

⚠ WARNING: If you experience a problem with your lift and are unable to service it yourself, contact GF Tech Support at 1.770.368.4700 or your GF authorized distributor.

9 SPECIFICATIONS

Info: All dimensions are given in inches unless otherwise specified.

SPECIFICATION		STS500	STS500M
External base width	Open	38.6" / 98cm	39.4" / 100 cm
	Closed	26" / 66cm	25.6" / 65 cm
Internal width, lifting boom		18.8" / 47.8cm	
Base height (for clearance)		4.3" / 11cm	
Base legs length		40.6" / 103cm	
Overall base length			49.2" / 125 cm
Lifting height range as measured from sling hooks.	Minimum	36.2" / 92cm	19.3" / 49 cm
	Maximum	70" / 178cm	74.8" / 190 cm
	Range	33.8" / 86 cm	55.5" / 141 cm
Mast height from floor			53.5" / 136 cm
Pad height from floor		13.8" / 35cm	
Maximum weight capacity		500 lb / 230 kg, EVENLY DISTRIBUTED	
Caster size		4" diameter locking; 3" diameter non-locking	
Lifting mechanism			24 DC actuator
Battery charger			AC 100V-240V to DC 29V, 1.5A

10 LIMITED WARRANTY

SCOPE OF WARRANTY

GF Health Products, Inc. ("GF") warrants to the original purchaser only that it will replace or repair components, at GF's sole discretion, that are defective in material or workmanship under normal use and service. All warranties are conditioned upon the proper use of the products strictly in accordance with good commercial practice and applicable GF instructions and manuals, including proper use and maintenance. To the extent that a third party warrants a component, GF conveys all of its rights under that warranty to the original purchaser, to the extent permitted.

This limited warranty shall only apply to defects that are reported in accordance with the provisions set forth in this warranty document, within the applicable warranty period and which, upon examination by GF or its authorized representative, prove to be a warranty item. (See Obtaining Warranty Service below) This limited warranty is not transferable.

The warranted components and time period are set forth below:

Lift frame and spreader bar:.....	3 years
Actuators:.....	2 years
Parts, including casters, control box, PCB, pendant, charger:.....	2 years
Batteries:.....	1 year

Labor is not included in the warranty.

The warranty period is as designated above. If a part is replaced under warranty, the original warranty period will not be affected. All other replacement parts will be subject to the warranty period specified.

The applicable warranty period shall commence from date of shipment to the original customer, unless there is an expiration date on the component in which case the warranty shall expire on the earlier of warranty period or the expiration date.

OBTAINING WARRANTY SERVICE

Customers located in the United States who wish to report a warranty issue, must contact GF directly by calling 1.770.368.4700 or by e-mailing a request to cs@grahamfield.com. Customers located outside the United States must contact the Distributor from whom they purchased the products. In both cases, further directions will be provided once the initial contact is made. This limited warranty shall only apply to defects that are reported within the applicable warranty period. Failure to abide by the specific directions will result in denial of the warranty claim.

The warranty does not cover and GF shall not be liable for the following:

- 1) Defects, damage, or other conditions caused, in whole or in part, by misuse, abuse, negligence, alteration, accident, freight damage, tampering or failure to seek and obtain repair or replacement in a timely manner;
- 2) Products which are not installed, used, or properly cleaned and maintained as required in the official manual for the applicable product;
- 3) Products considered to be of a non-durable nature including, but not limited to: filters, fuses, gaskets, lubricants, and charts;
- 4) Accessories or parts not provided by GF;
- 5) Matching of color, grain or texture except to commercially acceptable standards;
- 6) Changes in color caused by natural or artificial light;

- 7) Charges by anyone for adjustments, repairs, replacement parts, installation or other work performed upon or in connection with such products which are not expressly authorized in writing, in advance, by GF;
- 8) Any labor or shipping charges incurred in the replacement part installation or repair;
- 9) Costs and expenses of regular maintenance and cleaning; and
- 10) Representations and warranties made by any person or entity other than GF.

ENTIRE WARRANTY, EXCLUSIVE REMEDY AND CONSEQUENTIAL DAMAGES DISCLAIMER

THIS WARRANTY IS GF'S ONLY WARRANTY AND IS IN LIEU OF ALL OTHER WARRANTIES, EXPRESS OR IMPLIED. GF MAKES NO IMPLIED WARRANTIES OF ANY KIND INCLUDING ANY IMPLIED WARRANTIES OF MERCHANTABILITY OR FITNESS FOR A PARTICULAR PURPOSE. IF ANY MODEL OR SAMPLE WAS SHOWN TO THE CUSTOMER, SUCH MODEL OR SAMPLE WAS USED MERELY TO ILLUSTRATE THE GENERAL TYPE AND QUALITY OF THE PRODUCT AND NOT TO REPRESENT THAT THE PRODUCT WOULD NECESSARILY CONFORM TO THE MODEL OR SAMPLE IN ALL RESPECTS. THIS WARRANTY IS LIMITED TO THE REPAIR OR REPLACEMENT OF THE DEFECTIVE PARTS. GF SHALL NOT BE LIABLE FOR AND HEREBY DISCLAIMS ANY DIRECT, SPECIAL, INDIRECT, INCIDENTAL, EXEMPLARY OR CONSEQUENTIAL DAMAGES, INCLUDING, BUT NOT LIMITED TO: DAMAGES FOR LOSS OF PROFITS OR INCOME, LOSS OF USE, DOWNTIME, COVER, OR EMPLOYEE OR INDEPENDENT CONTRACTOR WAGES, PAYMENTS AND BENEFITS. CERTAIN STATES MAY CONFER ADDITIONAL RIGHTS REGARDING WARRANTIES AND IN THOSE STATES GF'S LIABILITY AND THE LIABILITY OF GF'S SUPPLIERS, SHALL BE LIMITED TO THE FULLEST EXTENT PERMITTED BY LAW.

The warranties contained herein, together with GF's current Terms and Conditions, contain all the representations and warranties with respect to the subject matter of this document, and supersede all prior negotiations, agreements and understandings with respect thereto. The recipient of this document hereby acknowledges and represents that it has not relied on any representation, assertion, guarantee, warranty, collateral contract or other assurance, except those set out in this document.

For additional information on this product or this warranty, please contact a GF Customer Service Representative.

NOTES:

- 1) Additional terms and conditions may apply. See GF's General Terms and Conditions on its website: www.grahamfield.com.
- 2) Freight claims must be notated on the appropriate shipping documents and must be made with immediacy. International, federal and state regulations govern specific requirements for freight claims. Failure to abide by those regulations may result in a denial of the freight claim. GF will assist you in filing the freight claim.
- 3) Claims for any short shipment must be made within three (3) days of the invoice date.

For additional information on this product or this warranty, please contact a GF Customer Service Representative.

11 INDEX

A

Assembly instructions 8

B

Before each use 17

C

Care and maintenance 17

Care of slings 18

CAUTION statement, significance 4

Charging the battery 9

Cleaning 18

Control box features 6

E

Easy Lift Sit-to-Stand features 6

Emergency lowering device 16

F

Features 6

H

Handling Procedures 7

I

Info statement, significance 4

Inspection 7

Intended use 3

Introduction 3

L

Lift and transfer from bed 14

Lift and transfer from chair 15

Lifting the patient 13

Lift preparation and procedure 12

Lubrication 17

M

Maintenance schedule 18

N

NOTICE statement, significance 4

O

Operating instructions — using the control box 10

Operating instructions — using the pendant 11

P

Preparation before lifting 12

S

Safety precautions 4

Safety statements, significance of 4

Setup 8

Shipping and transportation instructions 7

Sit-to-Stand Sling, fitting 12

Specifications 20

Storage 7

T

Troubleshooting 19

U

Unpacking 7

V

Videos, instructional, at www.grahamfield.com 12

W

Warnings 4

WARNING statement, significance 4

Warranty, limited 21

Weight capacity, maximum 4

LUMEX[®]

by graham-field

Manufactured For:
GF Health Products, Inc.
One Graham-Field Way, Atlanta, GA 30340
Made in Taiwan

© 2020, GF Health Products, Inc. All Rights Reserved.
Lumex is a registered trademark of GF Health Products, Inc.

LX_STS500-INS-LAB-RevB22



+1 770.368.4700

Information contained herein is subject to change without notice.
The most current and complete product information can be found on our website.
www.grahamfield.com

