



MATRIX 6200 SERIES SHOWN WITH PEDAL LOCK AND ADVANCED POSITIONING (APS) FEATURES OPERATING MANUAL

SAVE THIS MANUAL FOR FUTURE USE.

FDA RECOGNIZED STANDARD:

ANSI/AAMI STD ES60601-1

HEALTH CANADA RECOGNIZED STANDARD:

CAN/CSA C22.2 NO. 60601-1 (IEC 60601-1:20 12-ED.3.1)

INCLUDES INTERNATIONAL STANDARDS:

IEC 60601-1, IEC 60601-2-52

EMC STANDARD:

IEC 60601-1-2 ED. 4.1

TABLE OF CONTENTS

IMPORTANT SAFETY AND WARNING INFORMATION.....	3
IMPORTANT SAFETY AND WARNING INFORMATION.....	4
ELECTROMAGNETIC COMPATIBILITY (EMC) INFORMATION.....	4
ENTRAPMENT AND COMPLIANCE INFORMATION.....	5
RECOMMENDED MAINTENANCE.....	6
RECOMMENDED CLEANING AND DISINFECTION.....	7
CLEANING.....	7
MECHANICAL AND ELECTRICAL INFORMATION.....	8
MATRIX SERIES MECHANICAL.....	8
MATRIX SERIES ELECTRICAL.....	8
IDENTIFICATION LABEL LOCATION.....	8
WARNINGS.....	9
ENVIRONMENTAL SPECIFICATIONS.....	9
DISPOSAL OF EQUIPMENT AND ACCESSORIES.....	9
BED SETUP AND OPERATION INSTRUCTIONS.....	10
UNPACKING THE BED.....	10
HEADBOARD INSTALLATION.....	11
FOOTBOARD INSTALLATION.....	12
STANDARD MATTRESS RETAINER INSTALLATION.....	13
MATRIX SERIES WIREFORM WALLSAVER INSTALLATION.....	14
OPERATING THE CASTER PEDAL LOCK MECHANISM.....	14
PLUGGING IN THE FOOTBOARD STAFF CONTROL.....	15
MATRIX SERIES OPTIONAL ACCESSORIES.....	16
MATRIX SERIES HAND CONTROL PENDANT OPERATION.....	21
BED OPERATION - OPTIONAL STAFF CONTROL PANEL.....	22
BED OPERATION - CHAIR POSITION.....	23
BED OPERATION - TRENDELENBURG / REVERSE TRENDELENBURG POSITION.....	24
MATRIX SERIES ELECTRICAL CABLING.....	25
TROUBLESHOOTING.....	26
NOTHING WORKS — NO POWER.....	26
AUDIBLE SYSTEM WARNING (INTERMITTENT BEEP).....	26
KNEE DOESN'T LOWER, AUDIBLE SOLID BEEP WARNING.....	27
GENERAL TROUBLESHOOTING QUICK REFERENCE.....	28
LIMITED WARRANTY.....	30
PRODUCT NOTES.....	31

These Instructions for Use cover the Matrix Series with Standard and Advanced Positioning (APS), Standard Casters and Pedal-Lock option, for 35" and 42" Wide beds.

The Matrix Series is designed for Adult Patient and Caregiver use.





To order Matrix Series Bed service parts,
contact a GF Health Products, Inc. customer service representative at 1-770-368-4700.
For a list of Matrix Series bed service parts, visit www.grahamfield.com.

To order a Matrix Series bed or accessories,
contact a GF Health Products, Inc. sales representative at 1-770-368-4700.

Important Notice: Check all parts for shipping damage and test before using. In case of damage, DO NOT USE — contact qualified service personnel for examination and repair.

SIGNIFICANCE OF SAFETY STATEMENTS

Please note the following special statements, used throughout this manual, and their significance:

-  **DANGER:** Indicates a potential hazard situation or unsafe practice that, if not avoided, will result in death or serious personal injury.
-  **WARNING:** Indicates a potential hazard situation or unsafe practice that, if not avoided, could result in death or serious personal injury.
-  **CAUTION:** Indicates a potential hazard situation or unsafe practice that, if not avoided, could result in minor or moderate personal injury.
-  **NOTICE:** Indicates a potential hazard situation or unsafe practice that, if not avoided, could result in product or property damage.

IMPORTANT SAFETY AND WARNING INFORMATION

- ⚠ This product is a variable height, adjustable mattress platform. The expected service life of this product is fifteen years. Beds manufactured by Basic American Medical Products are designed for use within an institutional healthcare environment (i.e. assisted living, skilled nursing, transitional care, rehabilitation care, Environment (3), as defined in IEC60601-2-52 Safety Standard).
- ⚠ The maximum safe working load for the Matrix series bed, including bedding, resident / patient, support surface, and accessories, is 450 lb (204.1 kg), with weight evenly distributed, and maximum patient weight is 400 lb (181.4 kg). Accessory weights follow:

6200 BED ACCESSORIES	MAXIMUM WEIGHT
Headboard / Footboard (set)	up to 24 lb (8.1 kg)
Mattress	up to 34 lb (11.5 kg)
From 84" - 88" Length Extension Kit	22 lb (10 kg)
35" to 42" Width Extension Kit	15 lb (6.9 kg)
Trapeze Adapter	17 lb (7.7 kg)
Trapeze Bar Assembly	16 lb (7.3 kg)
Counter-Rotating Assists (set)	19 lb (8.6 kg)
Fixed Assist Bar	6 lb (2.7 kg)
Pivoting Assist Bar	9 lb (4 kg)

- ⚠ **WARNING:** To avoid risk of electric shock, this equipment must be connected to a supply mains with protective earth (i.e. a grounded outlet).
- ⚠ **DO NOT** open assemblies such as the Actuators, Hand Control Pendant, or Control Box. If unauthorized personnel perform work on these components, the manufacturer's warranty becomes void.
- ⚠ **DO NOT** use unauthorized parts, accessories, or adapters other than those specified / authorized by GF Health Products, Inc.
- ⚠ When operating the HI/LO, Knee, or Back Functions of the bed, **ALWAYS** ensure the confined individual is positioned properly within the confines of the bed. **DO NOT** let any extremities protrude over the side or between the bed rails when performing these functions.
- ⚠ The bed should be lowered to lowest position when resident is left unattended. **DO NOT** lower the bed when objects are beneath it. Failure to inspect under the bed can result in personal injury or property damage.
- ⚠ The bed's Hand Control Pendant Cable **MUST BE ROUTED AND SECURED PROPERLY** to ensure it does not become entangled and eventually severed during use. Also ensure electrical cords **DO NOT** get tangled around the bed, side rails, or legs during transport or normal operation of the bed.
- ⚠ When using nasal-type or masked-type administering equipment, all oxygen or air tubing **MUST BE ROUTED AND SECURED PROPERLY** to ensure the tubing does not become entangled and eventually severed during the normal operation of the bed.
- ⚠ Keep all moving parts free of obstructions (i.e. blankets / sheets, heating blankets / pads, wiring, etc.).
- ⚠ **DO NOT** use the assist devices as push handles for moving the bed. Assist devices can be deformed or broken if excessive side pressure is exerted. Assist devices are not meant for patients considered high risks for entrapment (i.e. patients with pre-existing conditions such as confusion, restlessness, lack of muscle control, altered mental status, either organic or medicinal, or a combination thereof). Additional safety measures should be considered for such high-risk patients.
- ⚠ **NEVER** permit more than one person on / in the bed at any time.
- ⚠ Body weight should be evenly distributed over the sleeping surface of the bed. **DO NOT** allow the patient to lie, sit, or lean in such a way that their entire body weight is placed only on the raised head or foot section of the bed. This especially applies when repositioning or transferring a patient in or out of the bed. Increased risk may occur when the patient's size and / or weight are inappropriate for the bed's dimensions or weight capacity.

- ⚠ Risk of entanglement or injury may occur if the mattress used with mattress retainers does not fill the entire width between stops or which compresses to less than 1.50 inches under user's weight.
- ⚠ Mattress must be properly sized to fit the mattress support platform and must remain centered on the support platform relative to State and Federal guidelines. Recommended minimum dimensions of mattress are 35-36 inches wide and 6 inches deep. Length and width should match the mattress support platform. Use of an improperly fitted mattress could result in injury or death. Standard mattresses are 35 inches wide and 6 inches deep, and wide mattresses are 42 inches wide and 6 inches deep.

IMPORTANT SAFETY AND WARNING INFORMATION

- ⚠ **IMPORTANT:** Powered air mattress surfaces may pose a risk of entrapment. Prior to use, ensure the therapeutic benefits outweigh the risk of entrapment.
- ⚠ The bed is intended for use within a temperature range of 10°C to 40°C. It has a water resistance rating of IPX4 and **IS NOT** to be power washed or submerged. The bed may be cleaned as needed using an appropriate dilution of mild soap and water.
- ⚠ The head / back and knee / foot decks can be lifted freely by hand for easy cleaning access when patients are not in the bed. If you lift the head / back or knee / foot deck for any reason, take great care when lowering back down to the prone position - ensure all body parts are clear of the space between the deck and the bed prior to slowly lowering any deck manually. To avoid injury, **DO NOT LET DECKS FALL FREELY FROM ANY ANGLE.**
- ⚠ **WARNING: ALWAYS** position bed so that the power cord and plug are easily accessed.
- ⚠ Proper routing and tie-off of electrical cabling, especially the power cord, is essential for proper operation and to ensure safety from electrical shock. In the event you are replacing any electrical cabling on your bed, you must ensure the cables are free from pinch points, obstructions, or stretched so tight that they may come loose or become damaged. In addition, cables should be tied off in such a way to secure them and keep them free from tangling on any part of the bed during normal operation. Refer to pages 25 and 28 for proper cable routing.

ELECTROMAGNETIC COMPATIBILITY (EMC) INFORMATION

- ⚠ **WARNING:** Medical Electrical Equipment needs special precautions regarding EMC and needs to be installed and put into service according to the EMC information provided in this manual.
- ⚠ **WARNING:** Electronic equipment may be influenced by Radio Frequency (RFI). Caution should be exercised with regard to the use of portable communications in the area around such equipment. Portable RF communications equipment (including peripherals such as antenna cables and external antennas) should be used no closer than 30 cm (12 inches) to any part of the bed including specified bed cables. Degradation of the performance of the bed could result.
- ⚠ IF RFI causes erratic behavior, unplug the electric bed immediately. Leave unplugged while transmission is in progress.
- ⚠ **WARNING:** The use of accessories, transducers, and cables other than those specified by the manufacturer may result in increased emissions or decreased immunity of the bed. GF Health Products, Inc. cables and accessories include motor cables, mains cable, pendant cables, back up battery and cable, USB port cable and UBL and cable.
- ⚠ **WARNING:** This bed should not be used adjacent to or stacked with other equipment. If adjacent or stacked use with other equipment is necessary, this bed and the other equipment should be observed to verify that they are operating normally.
- ⚠ **WARNING:** The EMISSIONS characteristics of this equipment make it suitable for use in industrial areas and hospitals (CISPR 11 class A). If it is used in a residential environment (for which CISPR 11 Class B is usually required) this equipment might not offer adequate protection to radio frequency communication services. The user might need to take mitigation measures, such as relocating or re-orienting the equipment.

ENTRAPMENT AND COMPLIANCE INFORMATION

On April 10, 2006, the FDA (U.S. Food and Drug Administration) released long-awaited guidelines for reducing the risk of bed entrapment: "Hospital Bed System Dimensional and Assessment Guidance to Reduce Entrapment". The new Guidance identifies potential entrapment areas and those body parts most at risk for entrapment; provides design criteria for manufacturers of new hospital/convalescent beds; recommends particular test methods to assess the conformance of existing hospital / convalescent bed systems; and answers frequently-asked questions about entrapment issues.

The new Guidance was a result of a long-standing collaboration between the FDA and the Hospital Bed Safety Workgroup (HBSW), formed in 1999. GF Health Products, Inc.'s ("GF") Long Term Care Bed division: Basic American Medical Products, is an HBSW charter member. As a result of our commitment to product safety, **all our current long-term care beds have been strictly tested and conform to the new FDA Guidance.**

The guidelines set forth by the FDA Guidance lay out specific dimensional limitations on potentially injury-threatening gaps and spaces that can occur between bed system components, such as rails, when not properly installed. GF Health Products, Inc. and Basic American Medical Products have conformed to these guidelines from a manufacturing aspect. However, entrapment issues can often arise when a healthcare provider / facility has not correctly assembled the components on a bed. It is essential that the provider / facility fully understand their responsibility in complying to the guidelines set forth by the FDA in order to avoid injury. To that end, we have provided the FDA's web address at right as a resource for understanding and following these guidelines for the safety of patients / residents.

It is also essential to have the correct bed components / accessories that correspond with the needs of the patient / resident and the particular bed you have purchased. Matching the correct bed component that correlates with the regulatory guidelines can be a daunting task. Our sales team at GF Health Products, Inc. and our friendly Customer Service Representatives at Basic American Medical Products can help you sift through the wide array of compliance and bed options. We will help you determine which bed / bed part is best for the patient's / resident's particular needs and help you with any compliance issues.

The MATRIX series bed and accessories listed in these instructions are in full compliance with FDA guidelines for reducing the risk of bed entrapment: "Hospital Bed System Dimensional and Assessment Guidance to Reduce Entrapment".





Details can be found at www.fda.gov.

RECOMMENDED MAINTENANCE

Regular maintenance of the Long Term Bed is necessary to ensure continuing proper and safe operation. Read and observe the following recommended maintenance schedule.

ITEM	RECOMMENDED INSPECTION PERIODS			MAINTENANCE		
	Inspect on Receipt	Every 3 Months	Every 6 Months		Date	Comments
Maintenance Inspection of All Components at Receipt of Shipment						
Ensure all parts / components are included (see "Unpacking The Bed").	X					
Check all bed components for obvious damage.	X					
Inspect the power cord for any cuts and / or damage.	X					
Check to see all actuator / motor cables are routed and connected properly to the control box.	X					
Mechanical Inspection of Assemblies						
Inspect all welds on the sleeping surface, frame, and base assemblies for stress fractures.			X			
Inspect all fasteners for wear and looseness.			X			
IMPORTANT: Lubricate all pivot points, actuator / motor clevis pins, and control arm clevis pins as needed. White Lithium Grease is recommended.			X			
Mechanical Inspection of Casters and Pedal Locking Mechanism						
Check the pedal locking mechanism to ensure it engages and disengages properly.		X				
Check the casters and stationary foot pads on both the head end and foot end for any damage, wear, or debris. Replace if needed.		X				
Check all rolling casters to ensure that they roll properly and are unobstructed.		X				
Electrical Inspection of Control Box, Hand Control Pendant, and Staff Control						
Check the external power cord that plugs into the control box for any chafing, cuts, or wear. Replace if damaged.		X				
Ensure all attaching hardware is securely tightened.		X				
Check all electrical connections for wear or fractures.		X				
Check the external backup battery (if you have one). Replace if needed.		X				
Check the hand control pendant cable for chafing, cuts, or wear.		X				
Check all hand control pendant functions - check to ensure each button and associated function work properly (i.e. head section rises when the HEAD UP button is activated).		X				
Electrical Inspection of Actuators / Motors						
Check the actuator / motor cables for any chafing, cuts, or wear.		X				
Check the range of movement on all motors to ensure they do not bind in the Full Up or Full Down positions.		X				

RECOMMENDED CLEANING AND DISINFECTION

-  **WARNING:** Unplug the bed from the electrical outlet before servicing or cleaning.
-  **DO NOT** steam clean or pressure wash any part of bed.
-  **DO NOT** use corrosive or powdered cleansers to clean any part of bed.
-  **DO NOT** immerse or soak any part of bed.

CLEANING

Cleaning/Disinfecting the Metal Components and Mechanical Accessories

All metal parts of the bed have been covered with a baked-on epoxy coating.

- To remove dust from the frame: Carefully raise the head and foot sections of the bed and wipe the frame with a clean, soft cloth. If disinfection is required, wipe with a clean, soft cloth dampened with a hospital grade disinfectant ***diluted per manufacturer's directions.***
- To clean coated metal parts: Wipe with a clean, soft cloth dampened with mild detergent and warm water. If disinfection is required, wipe with a clean, soft cloth dampened with a hospital grade disinfectant ***diluted per manufacturer's directions.***
- To clean the mattress deck: Remove the mattress, then wipe mattress deck with a clean, soft cloth dampened with mild detergent and warm water. Allow to air dry before replacing mattress. If disinfection is required, wipe with a clean, soft cloth dampened with a hospital grade disinfectant ***diluted per manufacturer's directions.***

Cleaning the Hand Control Pendant and Electrical Components

Wipe the hand control pendant and electrical components' external surface only with a clean, soft cloth dampened with mild detergent and warm water. If disinfection is required, wipe with a clean, soft cloth dampened with a hospital grade disinfectant ***diluted per manufacturer's directions.*** Air dry.

Cleaning the Mattress

Wipe with a damp cloth to remove any foreign material, then wipe with a clean, soft cloth dampened with mild detergent and warm water. If disinfection is required, wipe with a clean, soft cloth dampened with a hospital grade disinfectant ***diluted per manufacturer's directions.*** Air dry.

MECHANICAL AND ELECTRICAL INFORMATION

MATRIX SERIES-MECHANICAL			
Specification		6200 (35")	6200 (42")
Overall Bed Length (with boards and Wallsaver)	80"	86.6"	86.6"
	84"	90.6"	90.6"
Sleep Deck Width		35"	42"
Bed Width Including Boards		36"	42"
Maximum Height (floor to top of mattress support deck)		27"	27"
Minimum Height (floor to top of mattress support deck)		8.95"	8.95"
Maximum Head / Back Deck Angle		68°	68°
Maximum Knee / Foot Deck Angle		25°	25°
Maximum Trendelenburg / Reverse Trendelenburg Angle		13°	12°
Maximum Safe Working Load WITH WEIGHT EVENLY DISTRIBUTED - includes bedding, resident / patient, support surface, and accessories		450 lb (204.1 kg)	450 lb (204.1 kg)
Bed Mass (without assist devices or boards)		157 lb (71.2 kg)	157 lb (71.2 kg)

MATRIX SERIES-ELECTRICAL

Power / Frequency	120 Volt ~ / 50/60 Hz
Output Rating	24 Vdc
Maximum Amperage	4.5 Amps
Classification	Class 1, Type B
Power (Electrical) Cord	#18 AwG 3 Conductor Type SJT
Mode of Operations	10% max. Duty Cycle (2 minutes on / 18 minutes off)

Battery Pack and Charger can be purchased separately as accessories.

TYPICAL MATRIX SERIES BED IDENTIFICATION LABELS with Grounded Electrical Cable

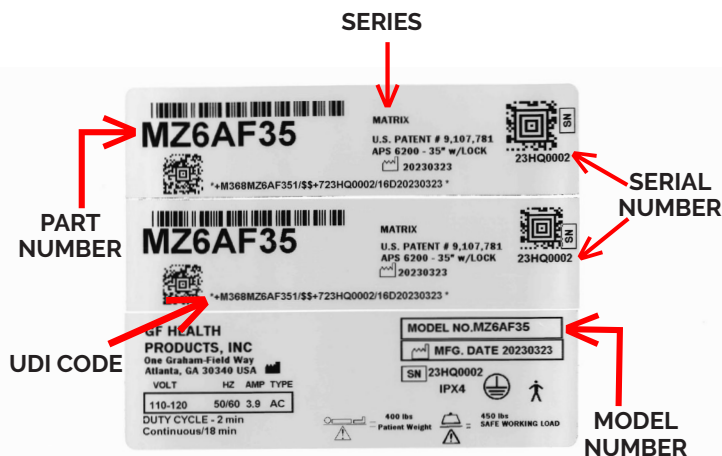

Bed labels are an important part of identifying the bed's make and model when ordering replacement parts. The Serial Number is essential if you are claiming parts or service under warranty. These helpful labels can be located on the main frame rails, immediately below the sleep decks on either side of the bed.

Have this **IMPORTANT** information ready when calling our Customer Service or Technical Support staff at 1-770-368-4700; it will allow us to better assist you and quickly answer your questions and concerns.

WARNING: Do not modify this equipment without authorization from GF Health Products, Inc.

NOTE: For Matrix Series Service Parts, Technical Assistance, and Information, call our Customer Service Department at 1-770-368-4700. For a list of Matrix Series bed service parts, visit www.grahamfield.com.

The following warning labels have been placed on the bed to help protect you and the bed from damage. Do not remove any labels from the bed.

WARNING!

DO NOT LOWER BED WHEN OBJECTS ARE BENEATH BED. FAILURE TO INSPECT UNDER BED CAN RESULT IN DAMAGE TO PROPERTY OR PERSONAL INJURY.

ATTENTION:

S'assurer de ne pas faire descendre le lit lorsque des objets se trouvent sous le lit. Ne pas inspecter le dessous du lit pourrait entraîner des dommages matériels et des risques de blessures.

CAUTION

THIS BED IS SUITABLE FOR USE ONLY WITH OXYGEN ADMINISTERING EQUIPMENT OF THE NASAL OR MASK TYPE OR A TENT COVERING ONLY THE UPPER HALF (HEAD END) OF THE BED. OXYGEN TENT CANOPIES SHOULD NOT EXTEND BELOW BED SPRING LEVEL. LOCK HAND CONTROL AT FOOT OF BED WHEN USING OXYGEN ADMINISTERING EQUIPMENT.

WARNING:

Incompatible mattresses can create hazards. Read Instructions for use.

ATTENTION:

Matelas incompatibles peuvent créer des dangers. Lisez les Instructions d'utilisation.



WARNING!

DO NOT LOWER BED WHEN OBJECTS ARE BENEATH BED. FAILURE TO INSPECT UNDER BED CAN RESULT IN DAMAGE TO PROPERTY OR PERSONAL INJURY.

ATTENTION:

CE LIT PEUT ETRE UTILISE UNIQUEMENT AVEC UN EQUIPMENT DESTINE A L'ADMINISTRATION D'OXYGENE DE TYPE NASAL OU MASQUE OU AVEC UNE TENTE RECOUVRANT SEULEMENT LA MOTTIE AVENT (TETE) DU LIT. LES COTES DE LA TENTE OXYGENE NE DOIVENT PAS SE PROLONGER PLUS DAS QUE LA SOMMIER DU LIT.

ENVIRONMENTAL SPECIFICATIONS

OPERATING CONDITIONS	
Ambient Temperature	10°C to 40°C
Relative Humidity	30% to 75% Non-Condensing
Atmospheric Pressure	700 hPa to 1060 hPa
Protected Against Splashing Water	IPX4

STORAGE AND TRANSPORT CONDITIONS	
Temperature	-10°C to 50°C
Relative Humidity	20% to 90%
Atmospheric Pressure	700 hPa to 1060 hPa

DISPOSAL OF EQUIPMENT AND ACCESSORIES



Follow local governing ordinances and recycling plans regarding disposal of the device or components normally used in operation. The device does not generate waste or residue in operation. Any accessories not part of the device **MUST** be handled in accordance with the individual product marking for disposal.

BED SETUP AND OPERATION INSTRUCTIONS

UNPACKING THE BED

- Ensure all parts / components are included.
- Check all bed components for obvious damage.
- Inspect the Power Cord for cuts or damage.
- Ensure all actuator / motor cables are routed and connected properly to the control box.

DISCARD

- 1) Foam Block
- 2) Honeycomb Block
- 3) Shipping Board
- 4) Cable Tie - Cut and Discard

KEEP

- 5) Panel Mount Kit
- 6) Mattress Retainer
- 7) Pendant Holster
- 8) Wireform Wallsaver

NOTE:

END OF POWER CORD IS COILED FOR SHIPPING AND TIED, WITH CABLE TIE, TO GRID WIRE WITH HAND CONTROL PENDANT, PENDANT CABLE AND HOLSTER.

CUT AND DISCARD CABLE TIE AROUND CABLES WHEN YOU UNPACK THE BED.

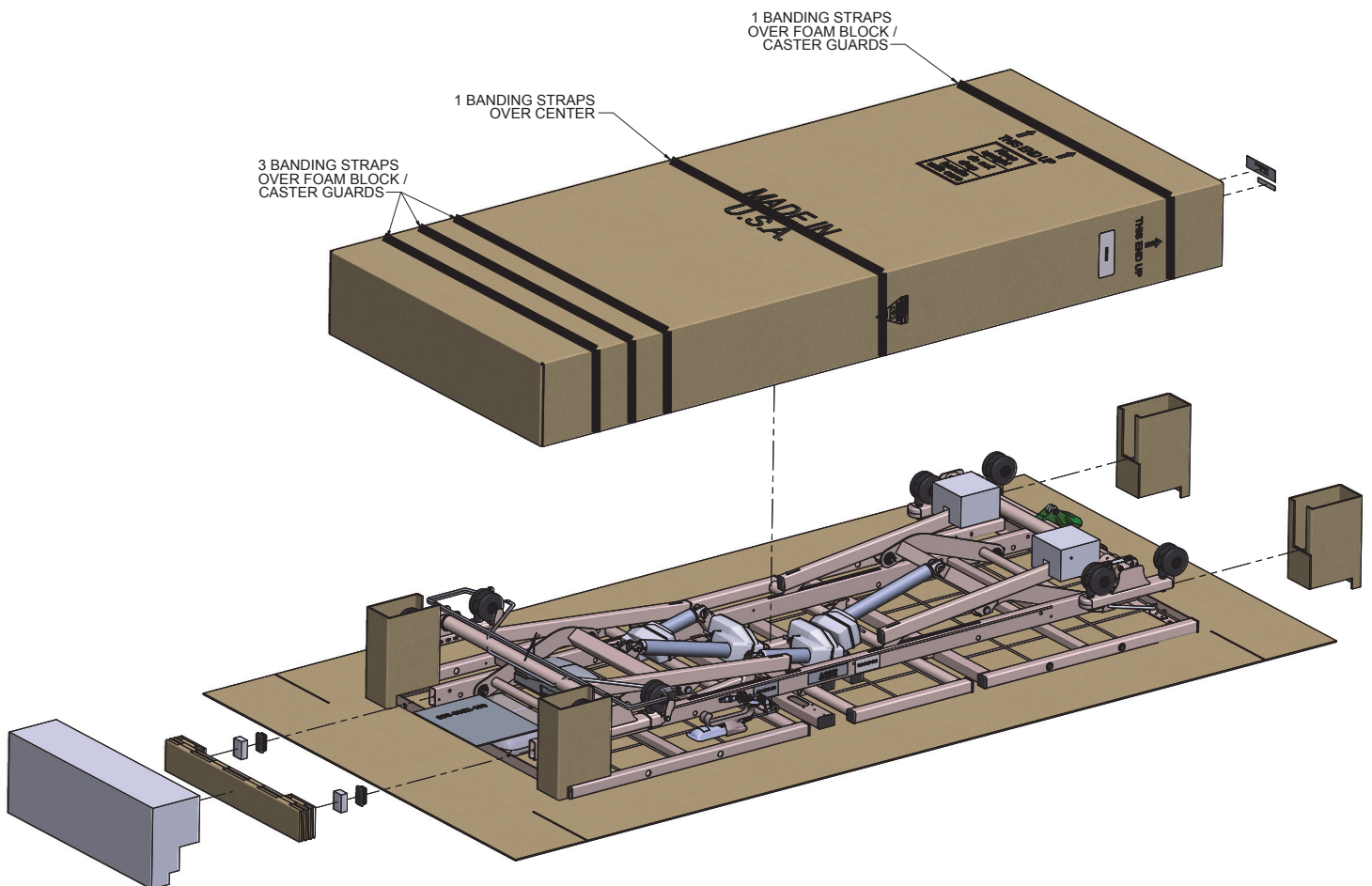

MATRIX 6200 SERIES

MATRIX 6200 SERIES HEADBOARD INSTALLATION *

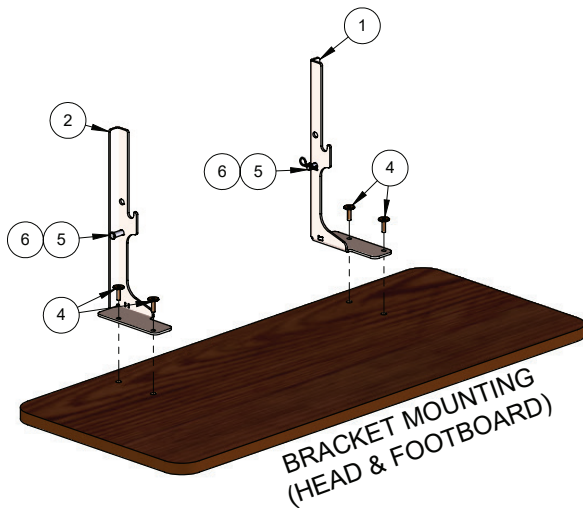

ITEM	QTY.	DESCRIPTION
1	2	BRACKET, BOARD MOUNTING RH
2	2	BRACKET, BOARD MOUNTING LH
3	1	CABLE TIES 12" NYLON
4	8	BOLT JCB-B 1/4-20 X 20MM HX FT BZ
5	4	5/16 x 1 1/2 CLEVIS PIN -ZI
6	4	1-9/16 HAIR PIN CLIP

1. The headboard may come with four pre-installed inserts - if not already installed, assemble the four inserts into the outside of the headboard as shown above.
2. Position a right (#1) and left (#2) mounting bracket on the inside of the headboard with headboard mounting holes facing outward as shown above.
3. Align the bracket top holes with the headboard top holes.
4. Insert a screw (#4) through each of the top holes and bottom holes and screw into each insert. Tighten loosely (hand tight) until after brackets are fastened to the bed frame.

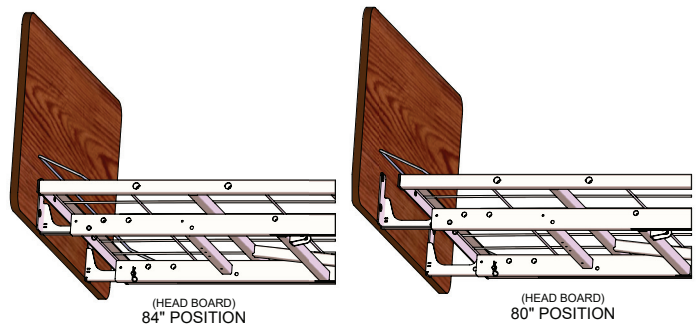

5. At the head deck end, slide the brackets into the main frame rail hollow ends.
6. **FOR 84" BEDS:** Slide the brackets in until the first bracket hole aligns with the upper rail hole as shown above. 80" and 84" bracket labels will be visible. Pin brackets to frame with Clevis Pins and Hair Pins provided.
7. **FOR 80" BEDS:** Slide the mounting brackets in until the second bracket hole aligns with the upper rail hole as shown above. Only 80" bracket label will be visible. Pin brackets to frame with Clevis Pins and Hair Pins provided.
8. Tighten screws with the hex key included in the kit.

MATRIX 6200 SERIES FOOTBOARD INSTALLATION

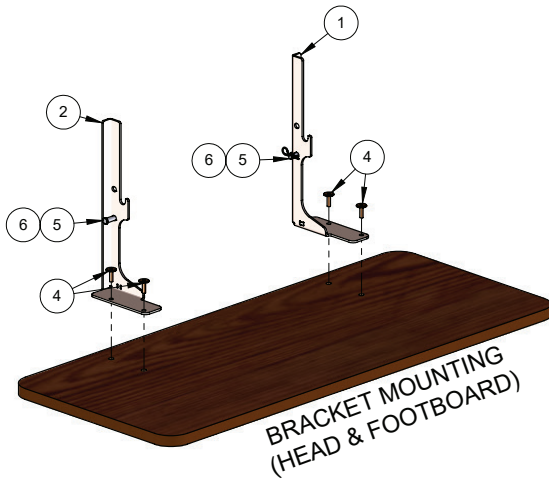

ITEM	QTY.	DESCRIPTION
1	2	BRACKET, BOARD MOUNTING RH
2	2	BRACKET, BOARD MOUNTING LH
3	1	CABLE TIES 12" NYLON
4	8	BOLT JCB-B 1/4-20 X 20MM HX FT BZ
5	4	5/16 x 1 1/2 CLEVIS PIN -ZI
6	4	1-9/16 HAIR PIN CLIP

1. The footboard may come with four pre-installed inserts - if not already installed, assemble the four inserts into the outside of the footboard as shown above.
2. Position a right (#1) and left (#2) mounting bracket on the inside of the footboard with footboard mounting holes facing outward as shown above.
3. Align the bracket top holes with the footboard top holes.
4. Insert a screw (#4) through each of the top holes and bottom holes and screw into each insert. Tighten loosely (hand tight) until after brackets are fastened to the bed frame.

* For residents taller than 185 cm (6' 1"), a 4" Length Extension Kit is available. Please contact Customer Service for more information.

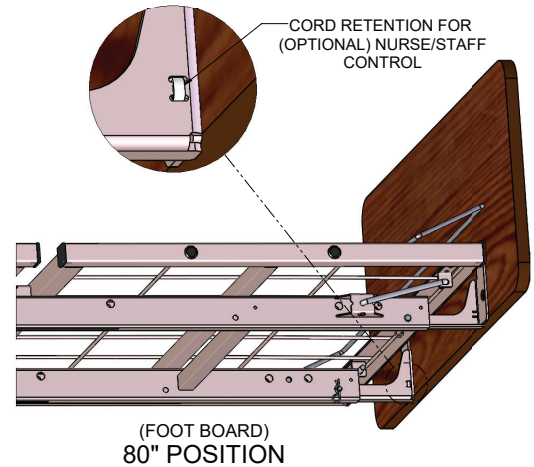
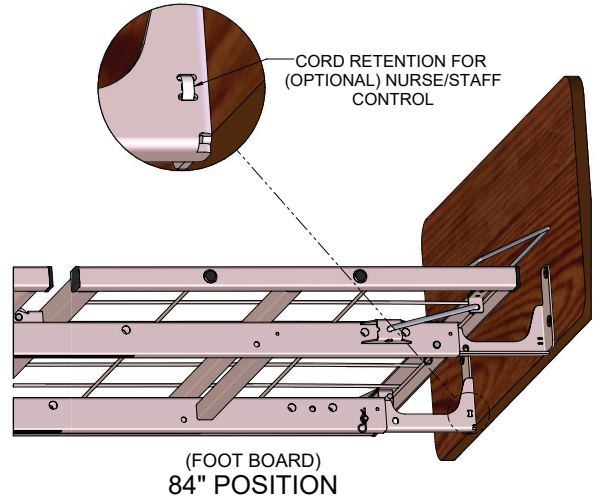

5. At the foot deck end, slide the brackets into the main frame rail hollow ends.
6. **FOR 84" BEDS:** Slide the mounting brackets in until the bracket hole aligns with the first rail hole as shown above. 80" and 84" bracket labels will be visible. Pin brackets to frame with Clevis Pins and Hair Pins provided.
7. **FOR 80" BEDS:** Slide the mounting brackets in until the bracket hole aligns with the second rail hole as shown above. Only 80" bracket label will be visible. Pin brackets to frame with Clevis Pins and Hair Pins provided.
8. Tighten screws with the hex key included in the kit.

STANDARD MATTRESS RETAINER INSTALLATION USING 35" OR 42" WIDTH MATTRESS RETAINER

Matrix 6200 Mattress Retainer

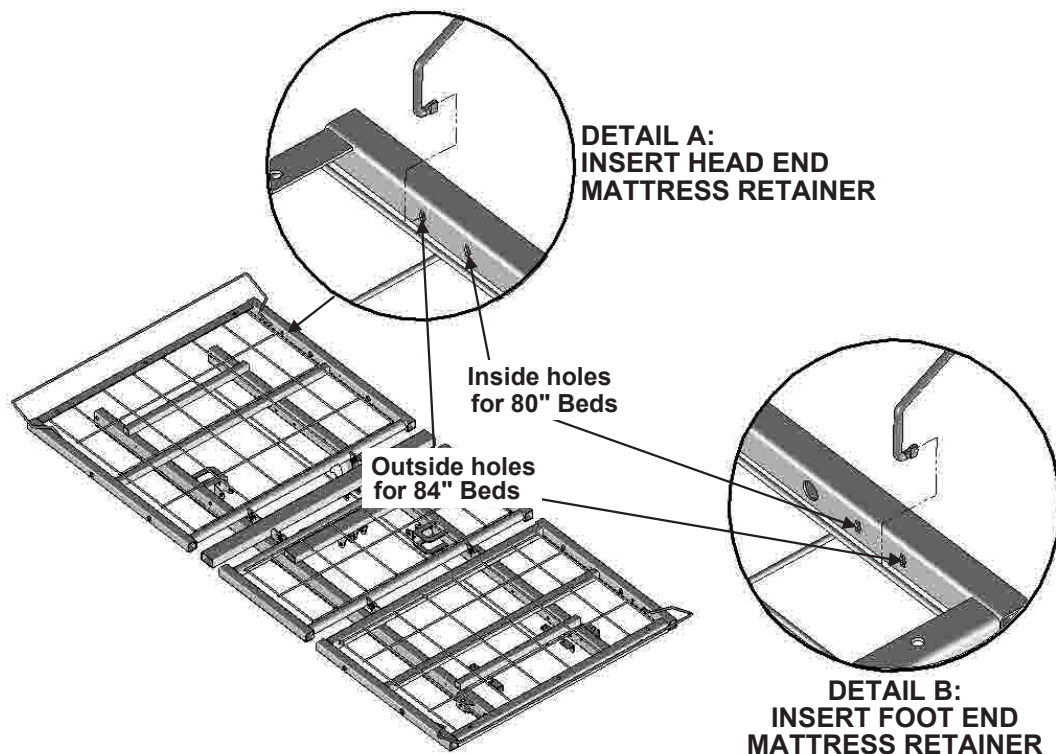

The Matrix Series Bed mattress retainer was designed to span the width of the sleeping surface.

1. Determine if you need to position your bed in an 84" or 80" configuration (84" length bed = outside holes; 80" length bed = inside holes).
2. Carefully squeeze the Mattress Retainer ends inward, toward the center of the retainer, and insert the ends into the proper holes. Lay the Mattress Retainer down so that the elbows rest on the decks and the long cross rod faces away from the bed as shown.

IMPORTANT: Ensure all three adjustable parts are properly positioned for 80" or 84" configurations (see pages 10, 11, 12, 13 and 15).

- ⚠ Be sure to use a mattress that is properly sized to fit the sleep deck, which will remain centered on the deck relative to State and Federal Guidelines. Use of an improperly fitted mattress could result in injury or death.
- ⚠ Use a properly sized mattress in order to minimize the gap between the side of the mattress and assist devices. This gap must be small enough to prevent resident / patient from getting their head or neck caught in this location.

6200 SERIES WIREFORM WALLSAVER INSTALLATION

WALLSAVER ASSEMBLY

1. Position the Wireform Wallsaver with bent end facing upward and tab ends facing inward as shown at right.
2. Determine the position desired (see WALLSAVER POSITIONS below).
3. Gently squeeze the Wallsaver tab ends inward toward the center of the Wallsaver and, holding the tabs parallel with the caster base holes, slide the tabs into the holes while letting the Wallsaver gently expand outward.
4. Turn the Wallsaver downward until it rests on the floor.



WALLSAVER REMOVAL

1. To remove or move the Wallsaver to a new position, raise the Wallsaver off the floor until the end tabs are horizontal.
2. Squeeze the ends toward the center of the Wallsaver until the end tabs slide out of the caster base holes.

WALLSAVER POSITIONS

There are two positions for the Matrix series Wallsaver. Holes nearest the center of the bed are for both 80" and 84" beds, and the holes closest to the head end are for use when a Trapeze Adapter is added to the bed.

The Standard Wallsaver will prevent the bed from making contact with the wall in all positions except Trendelenburg. If the Advanced Positioning (APS) bed is to be used in Trendelenburg position, the optional Trendelenburg Wallsaver must be used to prevent the bed from making contact with the wall.

Optional Trendelenburg Wallsaver is available when the bed is ordered with a Staff Control with Advanced Positioning.

OPERATING THE CASTER PEDAL LOCK MECHANISM

LOCKED POSITION

To lock the foot end casters, step on the red pedal until the caster lock engages.

UNLOCKED POSITION

To unlock the foot end casters, step on the green release pedal until the caster lock disengages.



PLUGGING IN THE FOOTBOARD STAFF CONTROL

STEP 1 - ATTACHING THE FOOTBOARD

The Matrix series bed features a footboard Staff Control; however, the footboard is ordered separately with your bed because of the variety of board styles available. If ordered at the same time as the bed, the Staff Control Assembly and Shroud Cover will be pre-installed to the Footboard at the factory.



DETAIL A:
Ensure lock end caps
are screwed on securely

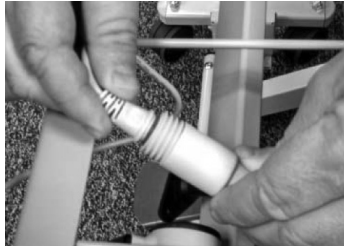

Improper Connection
(not completely seated)





Proper Connection
(completely seated)

STEP 2 - CONNECTING THE CABLES: REFER TO DETAIL A ABOVE

⚠ WARNING: CONNECT TO SINGLE WHITE STAFF CONTROL CABLE ONLY. POTENTIAL INJURY OR DAMAGE TO THE STAFF CONTROL AND / OR BED ELECTRONICS MAY RESULT FROM CONNECTING TO OTHER INCOMPATIBLE ELECTRONICS.

- a. Insert the T-Cable end (extending out the foot end with phone jack) into the round plug, making sure the phone jack is seated correctly inside the female plug (arrow to arrow – see DETAIL A and photos above).
- b. Screw on the round lock cap onto the Staff Control female plug to secure (See DETAIL A).

MATRIX SERIES OPTIONAL ACCESSORIES

Pivot Assist Bar	Fixed Assist Bar
	
ZA94700	ZA94900

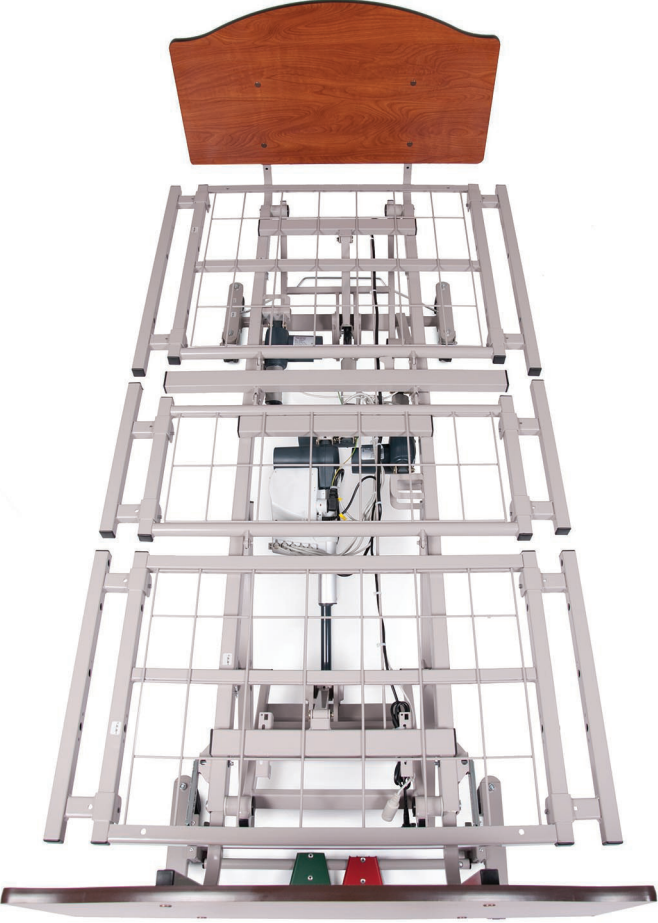
Counter-Rotating Assist (pair)	35" to 42" Width Extension Kit
	
ZA91300	ZA95600

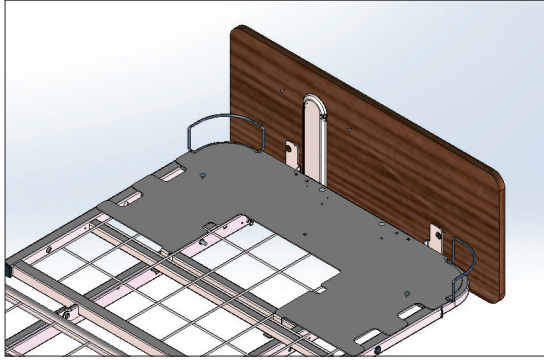
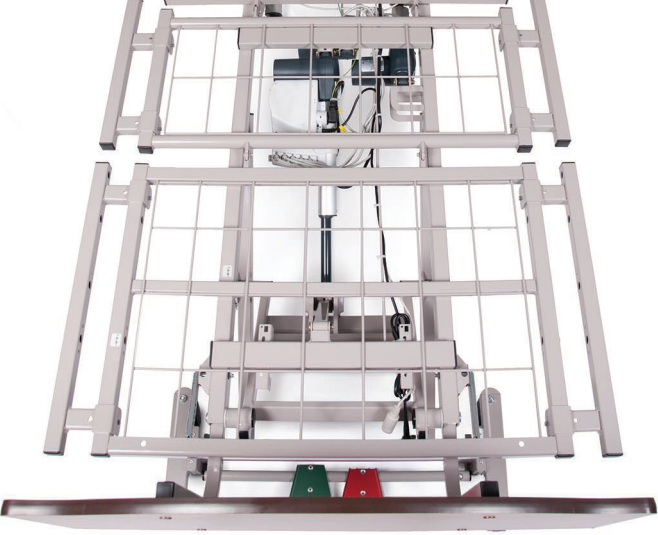

Length Extension Kit	
	
Extends from 84" to 88" Length Extension Kit: ZA95772	ZA95600

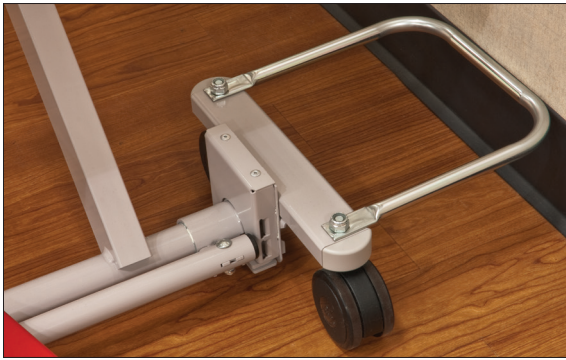

MATRIX SERIES OPTIONAL ACCESSORIES

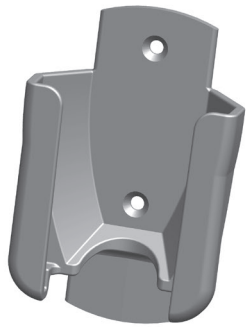

Space Intentionally Left Blank	Space intentionally Left Blank
XXXXXX	XXXXXX

Long (Trendelenburg) Wallsaver	Side-Wallsaver Bumper (set of 2)
	
ZA90070	ZA86200 (35") ZA89200 (42")

Plastic Pan Deck Kit	
	
ZA87500	

Board-Mounted Hand Control Pendant Holster	Backup Battery & Battery Charger
	
ZA79151	Backup Battery: ZA96100 Battery Charger: ZA96200

USB Phone Charger-Power Supply Kit	Under-Bed-Light Kit (must be used with Staff Control and/or APS Hand Control Pendant)
	
ZA96300	ZA90011

Advanced Positioning Hand Control with Trendelenburg / Reverse Trendelenburg	Standard Function Hand Control Pendant with Chair Position only	Advanced Positioning Hand Control Pendant with Chair Position Only
		
ZA831306	999-0900-301SP	999-0914-305SP
Advanced Positioning Staff Control		



ZL90000

Standard Positioning Staff Control

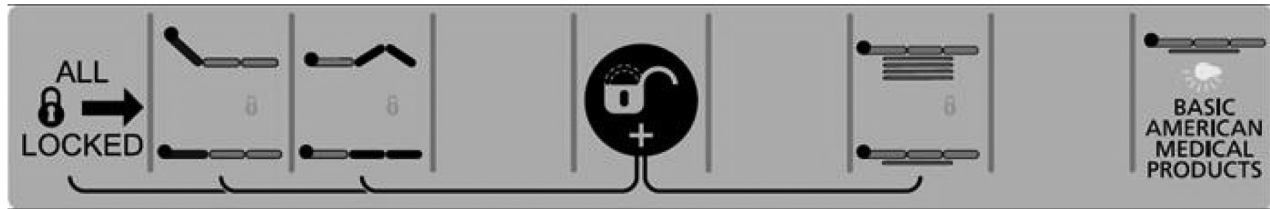

ZL90050

Board-Mounted IV Socket Kit

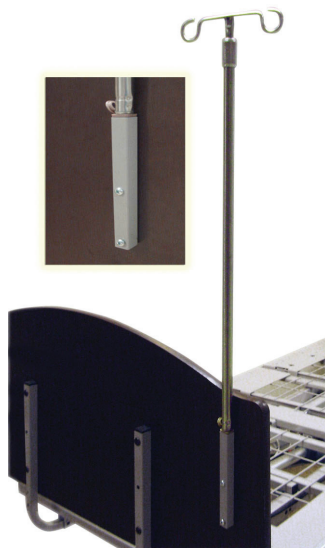

ZA19000

Edema Foot Ratchet Kit



ZA90030

1-Person Bed Transport Dolly (set)



ZA89900 unassembled

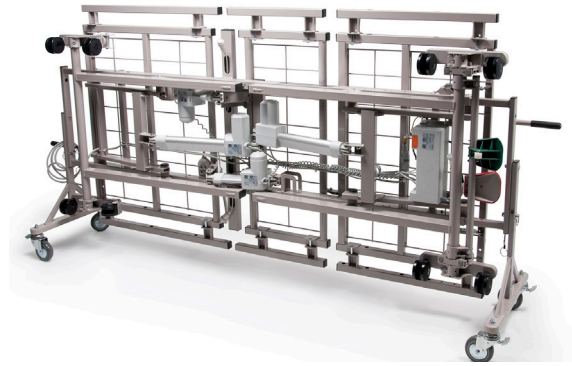

ZA89900 assembled with bed

MATRIX SERIES HAND CONTROL PENDANT OPERATION

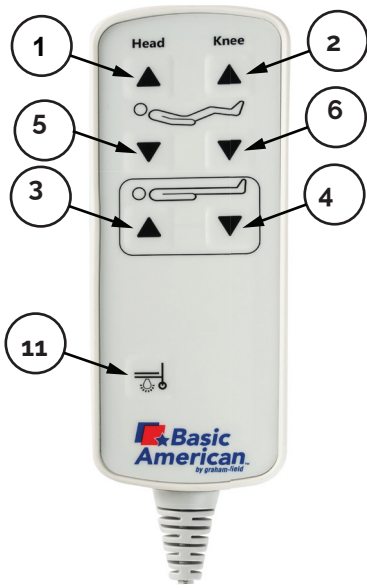

**MATRIX SERIES WITH
OPTIONAL STANDARD
POSITIONING HAND CONTROL
PENDANT**

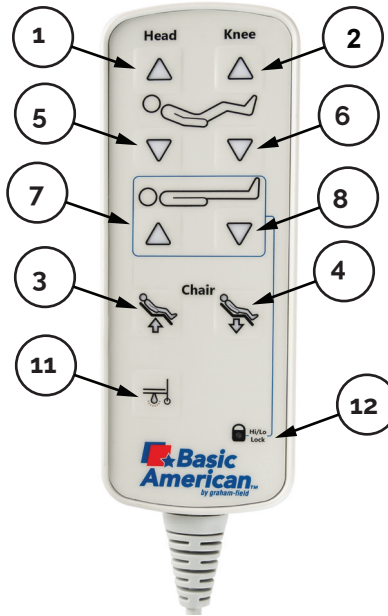

**MATRIX SERIES WITH
ADVANCED POSITIONING
HAND CONTROL PENDANT**

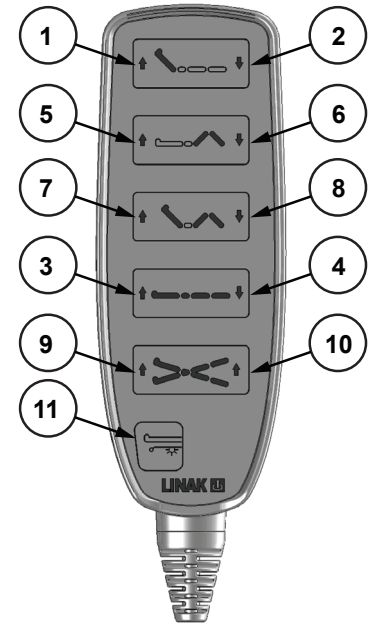

**OPTIONAL ACCESSORY:
MATRIX SERIES WITH TRENDELENBURG/
REVERSE TRENDELENBURG
HAND CONTROL PENDANT**

BUTTON	FUNCTION
1	HEAD DECK ANGLE UP
2	HEAD DECK ANGLE DOWN
3	HI/LO UP (RAISE ENTIRE BED)
4	HI/LO DOWN (LOWER ENTIRE BED)
5	KNEE AND FOOT DECK ANGLE UP
6	KNEE AND FOOT DECK ANGLE DOWN

BUTTON	FUNCTION
7	SET TO CHAIR POSITION
8	UNDO CHAIR POSITION
9	REVERSE TRENDELENBURG POSITION
10	TRENDELENBURG POSITION
11	OPTIONAL UNDERBED LIGHT
12	OPTIONAL HI/LO FUNCTION LOCKOUT

NOTE:

The MATRIX Series Hand Control Pendant can be plugged into the T-Cable plugs on either side of the bed for easy access. The opposite side of the T-Cable should always have the provided cap attached for safety.

The two vertical ends of the double T-Cable run toward the foot end of the bed, with one vertical end plugging directly into the control box (or optional Underbed Light if your bed has that feature) and the other longer end runs along the tie rod and extends out the foot end and plugs into the Staff Control cable.

Optional HI/LO Function Lockout (Hand Control Pendant with Advanced Positioning ONLY, shown at above center)

A Lockout Key, shown at right, is used to activate/deactivate the HI/LO Function Lockout by holding it over the center bottom portion of the hand control as shown at center right. The Lockout LED indicator will turn on/off when activated/deactivated.

**LOCKOUT
KEY**



BED OPERATION - OPTIONAL STAFF CONTROL PANEL *

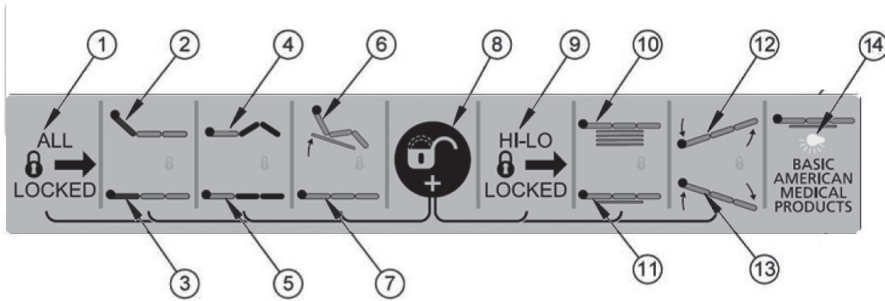

Press "Underbed Light" button (#14) to turn underbed light on or off.

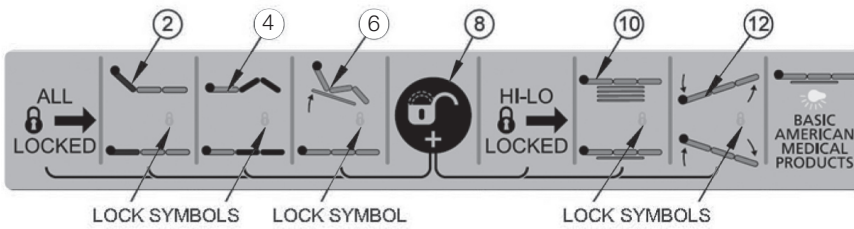

Press "Head", "Knee", or "Chair" and "Key" at the same time to unlock individual lock out functions.

Press "HI/LO Locked" to lock out "HI/LO", "Trendelenburg", and "Reverse Trendelenburg" functions.

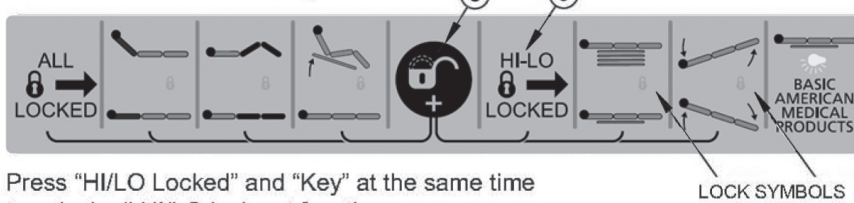

Press "HI/LO Locked" and "Key" at the same time to unlock all HI/LO lock out functions.

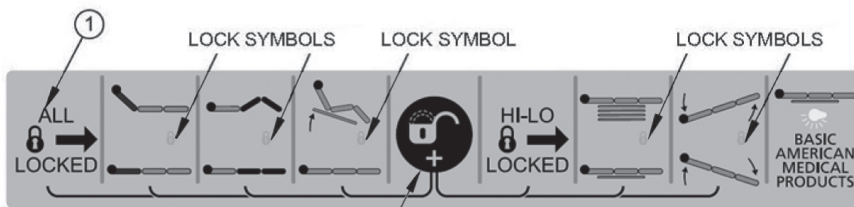

Press "All Locked" and "Key" at the same time to unlock all functions.



1	ALL LOCKED BUTTON
2	HEAD DECK UP BUTTON
3	HEAD DECK DOWN BUTTON
4	KNEE & FOOT DECK UP BUTTON
5	KNEE & FOOT DECK DOWN BUTTON
6	CHAIR POSITION BUTTON
7	UNDO CHAIR POSITION BUTTON
8	KEY LOCK / UNLOCK BUTTON
9	HI / LO (T / TR) LOCKED BUTTON
10	HI / LO UP BUTTON
11	HI / LO DOWN BUTTON
12	TRENDELENBURG
13	REVERSE TRENDELENBURG
14	UNDERBED LIGHT BUTTON

LOCK OUT SINGLE FUNCTIONS

To individually lock out the "Head," "Knee," "Chair," and "Hi / Lo Functions," press the appropriate top icon (2, 3, 4, 10, or 12) button and the "Key" button (8) at the same time. An orange LED lock symbol will appear under the related icon.

To "Unlock" any of the individual functions, press the top icon (2, 3, 4, 10, or 12) and the "Key" button (8) simultaneously. LED lights will NOT show up.

LOCK OUT HI / LO FUNCTIONS

To lock out the functions for raising and lowering the entire bed and tilting the bed for Trendelenburg positions, press the "HI / LO Locked" (9) button. Orange LED lock symbols will appear under the HI / LO and Trendelenburg icons.

To "Unlock" all HI / LO functions, press the "HI / LO Locked" button (9) and the "Key" button (8) simultaneously. Orange LED lights will NOT show up.

LOCK OUT EVERYTHING

To lock all functions, press the "ALL Locked" button (1). Orange LED lock symbols will appear under the "Head," "Knee," "Chair," "HI / LO," and "Trendelenburg / Reverse Trendelenburg" icons.

To "Unlock" all functions, press the "All Locked" button (1) and the "Key" button (8) simultaneously. Orange LED lights will NOT show up.

Staff Control with Advanced Positioning functions is shown above. Staff Control with Standard Positioning functions is shown at left; all standard functions operate the same as those defined above.

BED OPERATION - CHAIR POSITION

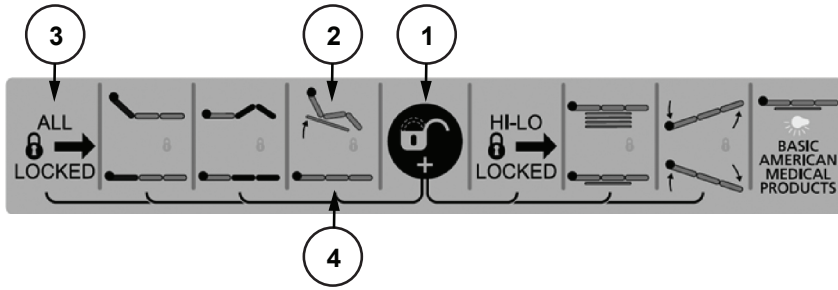

1. Ensure the Chair position on the Staff Control panel is not locked out (*orange lock icon*). To unlock, press Lock icon button #1 and Chair icon button #2 (or “All Locked” button #3) simultaneously.

2. To move the bed to Chair position (*foot and knee decks angled up, head deck angled up, and head of bed tilted up*), press Chair icon button #2.

To release the chair feature and return the bed to horizontal position, press Flat Bar icon #4.

HEAD
END



FOOT
END

The Chair feature can also be operated using the Hand Control Pendant.

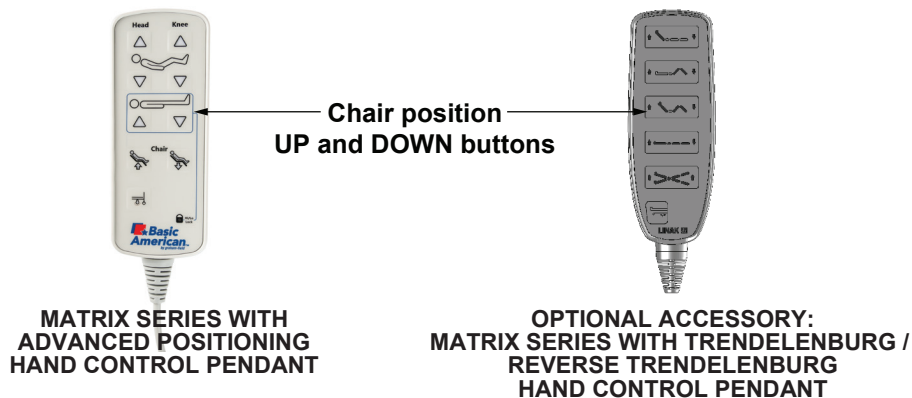

BED OPERATION - TRENDELENBURG / REVERSE TRENDELENBURG POSITION

1. Ensure the Staff Control HI/LO function is not locked out (*orange lock icon*). To unlock, simultaneously press Key 1 and HI/LO Locked button 2.
2. To move the bed to Trendelenburg position (foot end up), press button 3.
3. To move the bed to Reverse Trendelenburg position (head end up), press button 4

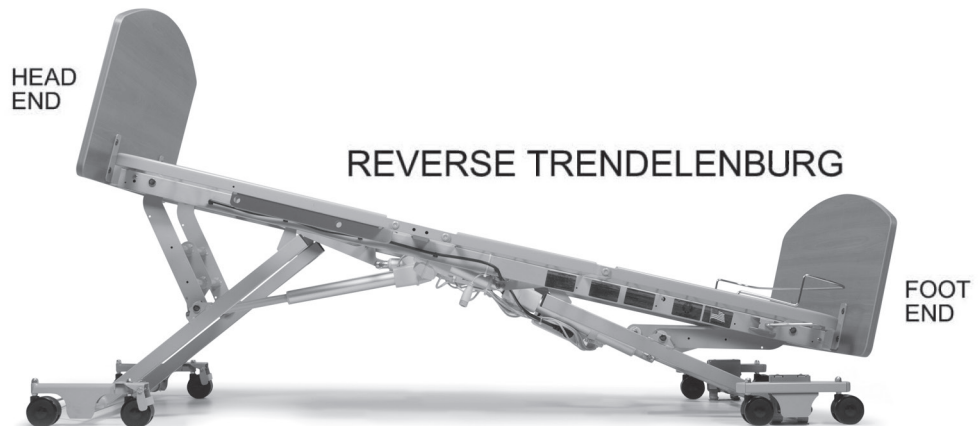
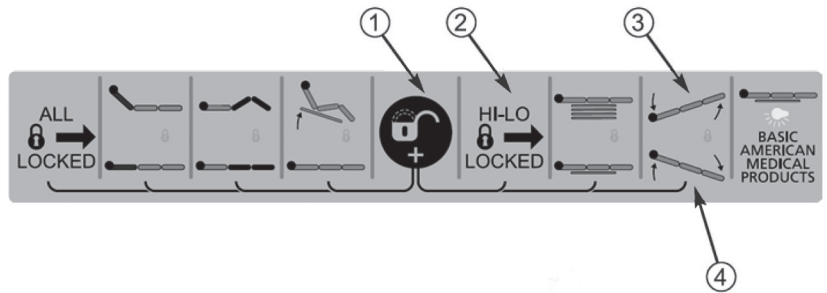

MATRIX SERIES ELECTRICAL CABLING

MOTOR CABLES

1. Route cables as shown below. With the right angle plug going to the control box, and the straight plug going to the motor.
2. Use 100-1100-055 to bundle cables as they leave the control box.
3. Once all of the cables are plugged in and snapped into the correct slot as shown below, close the lid of the control box.

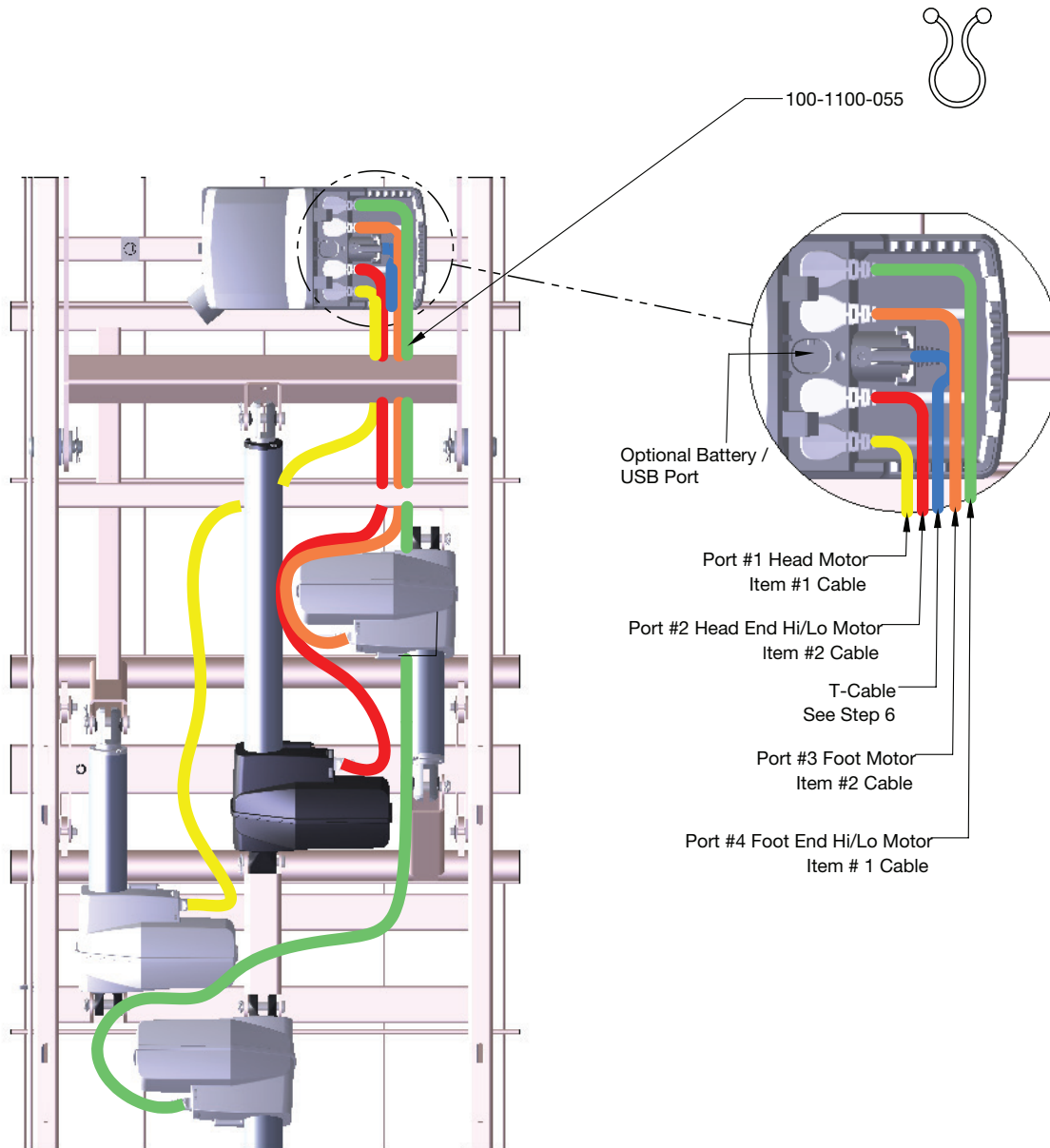

TROUBLESHOOTING

NOTHING WORKS — NO POWER

1. Verify the outlet is supplying power.
2. Ensure the power cord is not pinched, frayed, or damaged in any way. Replace the Power Cord if damaged.
3. Ensure all power cord, T-Cable, Hand Control Pendant, and Control Box receptacles and plugs are seated and fully inserted.
4. Ensure the Staff Control does not have functions locked out.
5. Plug the Hand Control Pendant directly into the Control Box. If the bed works, replace the T-Cable.
6. Replace the Hand Control Pendant with a known good operating Pendant. If the bed works, replace the Hand Control Pendant.
7. If the bed still isn't functional after steps 1-6, replace the Control Box.
8. New Control Box installation will require motor Initialization.

NOTE: Service Control Box Motor Initialization Procedure as well as detailed troubleshooting and service instruction can be found at www.grahamfield.com.

AUDIBLE SYSTEM WARNING (INTERMITTENT BEEP)

NOTE: A function that is faulty or has lost motor position will cause the Control Box to beep intermittently when the faulty function's Hand Control Pendant button is depressed. All buttons depressed after the error function will also be non-functional and will cause a Control Box beep. If equipped with a Staff Control, the staff icons will also flash to indicate a system error.

When the Audible Beeping Error signal is heard:

1. On the Hand Control Pendant, simultaneously press and hold both the **HI/LO UP** and **HI/LO DOWN** buttons (the Control Box should start beeping) for approximately five seconds until beeping stops.
2. Reinitialize the motors by lowering the bed completely. In the following order, press the Hand Control Pendant buttons until the motors stop:
 - a. **HI/LO DOWN**
 - b. **HEAD DECK ANGLE DOWN**
 - c. **KNEE AND FOOT DECK ANGLE DOWN**
3. This lowering of the motors will reset the system and should resolve minor synchronization or position lost issues. Check the bed functionality.
4. If an audible error beep occurs during reset lowering of a function or while checking functionality, the function that initiated the beep is faulty.
5. After the faulty function initiates the beep, all other button functions will cause a beep and become non-functional.
6. To operate and use the other good functions, perform step 1 again to reset the system.
7. Reinitialize the motors as in Step 2 but only lower the motors that did not initiate the audible error beep.
8. These functions will operate normally until the faulty function button is pressed again.

NOTE: If the issue is not resolved, go to www.grahamfield.com for more detailed troubleshooting and service instructions.

KNEE DOESN'T LOWER, AUDIBLE SOLID BEEP WARNING

NOTE: As a result of the bed's programmed capability to achieve APS positioning, the Knee Motor will not lower if the HI/LO motors are not level. This is a safety measure to prevent the patient from sliding out of bed while in Chair Position.

The control box will emit a solid beep warning when attempting to lower the knee if this condition is present.

NOTE: This condition can also happen with beds not equipped with APS positioning or if the frame appears to be visually level. If the solid beep is present when trying to lower the knee:

1. Return the bed frame to a level position by pressing the Hand Control Pendant **UNDO CHAIR** button until the bed is level. Continue holding the button down until the knee retracts.
2. If not equipped with chair function, or if step 1 did not resolve the issue, lower the bed completely: press the **HI/LO DOWN** button until the motors shut off.
3. Now lower the knee using the **KNEE AND FOOT DECK ANGLE DOWN** button.

NOTE: If the issue is not resolved, go to www.grahamfield.com for more detailed troubleshooting and service instructions.

GENERAL TROUBLESHOOTING QUICK REFERENCE

NOTE: Advanced Service Troubleshooting Procedures, Flow Charts and Service Components can be found at www.grahamfield.com.

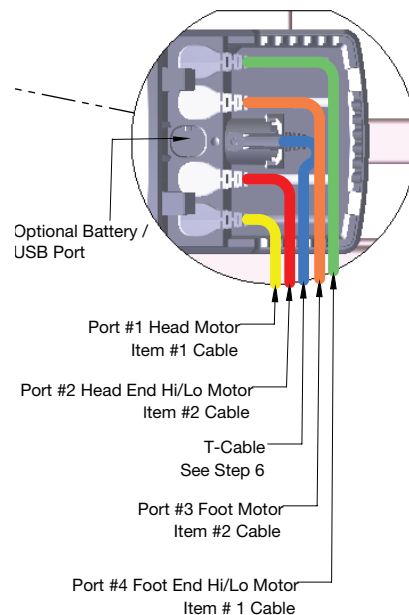

Plugs and Receptacles:

Loose plug connections or incorrect plug positioning will result in erroneous or no system error signals and faulty operation. **Before troubleshooting, ensure all plugs are engaged fully in their receptacles and located in the correct ports.**

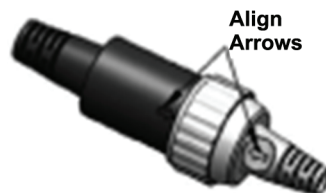

Motors

Test any motor by plugging it into a known good Control Box port.

Example: If the head motor is not functioning and the knee motor is functional, plug the head motor into the knee Control Box port and operate the head motor with the knee Pendant button. If the head motor operates, it is good. If not working in the good port, replace the head motor or motor cable.

Motor Cables

Motor cables are interchangeable. Test a motor cable by attaching it to a known good motor and known good Control Box port and operating it.

T-Cables

Test a T-Cable by unplugging it from the Control Box port and plugging the Hand Control Pendant directly into the Control Box. If the bed functions with the Hand Control Pendant, replace the T-Cable.

Hand Control Pendants

Test a Hand Control Pendant by replacing it with a known good Pendant. If the Bed now operates, replace the Hand Control Pendant.

Staff Controls

Test a Staff Control by replacing it with a known good Staff Control. If the Bed now operates, replace the Staff Control.

Control Box

Test a Control Box by replacing it with a known good Control Box. If the bed now operates, replace the Control Box. If a known good Control Box is not available, go to www.grahamfield.com for detailed Troubleshooting Procedures.

LIMITED WARRANTY

SCOPE OF WARRANTY

GF Health Products, Inc. ("GF") warrants to the Original Purchaser only that it will replace or repair components, at GF's sole discretion, that are defective in material or workmanship under normal use and service. All warranties are conditioned upon the proper use of the products strictly in accordance with good commercial practice and applicable GF instructions and manuals, including proper use and maintenance. To the extent that a third party warrants a component, GF conveys all of its rights under that warranty to the Original Purchaser, to the extent permitted. Original Purchaser is one who purchases this product new and unused from GF or a Certified GF Dealer/Distributor.

This limited warranty shall only apply to defects that are reported in accordance with the provisions set forth in this warranty document, within the applicable warranty period and which, upon examination by GF or its authorized representative, prove to be a warranty item. (See Obtaining Warranty Service below) This limited warranty is not transferable.

The warranted components and time periods are set forth below:

Mainframe and welds:	15 years
Control box and actuators:	4 years
Pendant control and cables:	3 years
All other durable components not listed above:	2 years
Replacement Parts ‡:	90 days

* Labor is not included in the warranty.

‡ The warranty period is as designated above. If a part is replaced under warranty, the original warranty period will not be affected. All other replacement parts will be subject to the warranty period specified.

The applicable warranty period shall commence from date of shipment to the Original Purchaser, unless there is an expiration date on the component in which case the warranty shall expire on the earlier of warranty period or the expiration date.

OBTAINING WARRANTY SERVICE

Contact the Dealer/Distributor from whom the product was purchased. If there is not a Dealer/Distributor, you must contact GF directly by calling (770) 368-4700 or by e-mailing a request to cs@grahamfield.com. The Customer Service Representative will provide specific directions. Failure to abide by the specific directions will result in denial of the warranty claim.

The warranty does not cover and GF shall not be liable for the following:

- 1) Defects, damage, or other conditions caused, in whole or in part, by misuse, abuse, negligence, alteration, accident, freight damage, tampering or failure to seek and obtain repair or replacement in a timely manner;
- 2) Products which are not installed, used, or properly cleaned and maintained as required in the official manual for the applicable product;
- 3) Products considered to be of a non-durable nature including, but not limited to: filters, fuses, gaskets, lubricants, and charts;
- 4) Accessories or parts not provided by GF;
- 5) Matching of color, grain or texture except to commercially acceptable standards;
- 6) Changes in color caused by natural or artificial light;
- 7) Charges by anyone for adjustments, repairs, replacement parts, installation or other work performed upon or in connection with such products which are not expressly authorized in writing, in advance, by GF;
- 8) Any labor or shipping charges incurred in the replacement part installation or repair;
- 9) Costs and expenses of regular maintenance and cleaning; and
- 10) Representations and warranties made by any person or entity other than GF.

ENTIRE WARRANTY, EXCLUSIVE REMEDY AND CONSEQUENTIAL DAMAGES DISCLAIMER

TO THE GREATEST EXTENT PERMITTED BY LAW, THIS WARRANTY IS GF'S ONLY WARRANTY AND IS IN LIEU OF ALL OTHER WARRANTIES, EXPRESS OR IMPLIED. EXCEPT IN CASES WHERE IMPLIED WARRANTIES MAY NOT BE VALIDLY WAIVED, GF MAKES NO IMPLIED WARRANTIES OF ANY KIND INCLUDING ANY IMPLIED WARRANTIES OF MERCHANTABILITY OR FITNESS FOR A PARTICULAR PURPOSE. IF ANY MODEL OR SAMPLE WAS SHOWN TO THE CUSTOMER, SUCH MODEL OR SAMPLE WAS USED MERELY TO ILLUSTRATE THE GENERAL TYPE AND QUALITY OF THE PRODUCT AND NOT TO REPRESENT THAT THE PRODUCT WOULD NECESSARILY CONFORM TO THE MODEL OR SAMPLE IN ALL RESPECTS. THIS WARRANTY IS LIMITED TO THE REPAIR OR REPLACEMENT OF THE DEFECTIVE PARTS. GF SHALL NOT BE LIABLE FOR AND HEREBY DISCLAIMS ANY DIRECT, SPECIAL, INDIRECT, INCIDENTAL, EXEMPLARY OR CONSEQUENTIAL DAMAGES, INCLUDING, BUT NOT LIMITED TO: DAMAGES FOR LOSS OF PROFITS OR INCOME, LOSS OF USE, DOWNTIME, COVER, OR EMPLOYEE OR INDEPENDENT CONTRACTOR WAGES, PAYMENTS AND BENEFITS. CERTAIN STATES AND COUNTRIES MAY CONFER ADDITIONAL RIGHTS REGARDING WARRANTIES AND IN THOSE INSTANCES, GF'S LIABILITY AND THE LIABILITY OF GF'S SUPPLIERS, SHALL BE LIMITED TO THE FULLEST EXTENT PERMITTED BY LAW.

The warranties contained herein, together with GF's current Terms and Conditions, contain all the representations and warranties with respect to the subject matter of this document, and supersede all prior negotiations, agreements and understandings with respect thereto. The recipient of this document hereby acknowledges and represents that it has not relied on any representation, assertion, guarantee, warranty, collateral contract or other assurance, except those set out in this document.

For additional information on this product or this warranty, please contact a GF Customer Service Representative.

NOTES:

- 1) Additional terms and conditions may apply. See GF's General Terms and Conditions on its website: www.grahamfield.com.
- 2) Freight claims must be notated on the appropriate shipping documents and must be made with immediacy. International, federal and state regulations govern specific requirements for freight claims. Failure to abide by those regulations may result in a denial of the freight claim. GF will assist you in filing the freight claim.
- 3) Claims for any short shipment must be made within three (3) days of the invoice date.

If you have questions regarding a bed's warranty, contact Basic American Medical Products at 1.770.368.4700.

PRODUCT NOTES



Manufactured By:
GF Health Products, Inc.
One Graham-Field Way, Atlanta, GA 30340
Made in USA

© 2023, GF Health Products, Inc. All Rights Reserved.
Basic American Medical Products is a trademark
of GF Health Products, Inc.

BA_999-0952-190-INS-LAB-RevA23



+1 770.368.4700

Information contained herein is subject to change without notice.
The most current and complete product information can be found on our website.
www.grahamfield.com

