



**Series FR587W Deluxe Clinical Care Recliner,
Extra Wide**

**Series FR587WH Deluxe Clinical Care Recliner,
Extra Wide, with Heat and Massage**

**Series FR587WHO Deluxe Clinical Care Recliner,
Extra Wide, with Heat Only**



ASSEMBLY AND OPERATING INSTRUCTIONS

SAVE THIS MANUAL FOR FUTURE USE.

CONTENTS

INTRODUCTION	3
INTENDED USE	3
IMPORTANT SAFETY PRECAUTIONS— READ BEFORE USE	3
WARNINGS.....	3
ASSEMBLY	5
UNPACKING	5
UPHOLSTERED BACK ASSEMBLY	5
OPERATION	8
TENTE® CASTERS.....	8
SIDE TABLE OPERATION	9
SIDE PANEL OPERATION	10
RECLINER OPERATION.....	11
FIRST POSITION (UPRIGHT POSITION)	11
SECOND POSITION (FIRST RECLINE POSITION)	11
THIRD POSITION (SECOND RECLINE POSITION)	12
TRENDELENBURG POSITION (ALSO KNOWN AS SHOCK POSITION).....	12
GAS SPRING TROUBLESHOOTING GUIDE.....	13
ADJUSTING CABLE TENSION.....	13
RECLINERS WITH HEAT AND MASSAGE OR HEAT ONLY FEATURE.....	14
INSTALLATION AND OPERATING GUIDE	14
DESCRIPTION.....	14
CONNECTION	14
MAIN COMPONENTS	14
HEAT AND MASSAGE / HEAT ONLY INSTALLATION INSTRUCTIONS	15
HEAT AND MASSAGE / HEAT ONLY UNIT OPERATION INSTRUCTIONS	17
HEAT AND MASSAGE / HEAT ONLY UNIT TROUBLESHOOTING GUIDE.....	19
CARE AND MAINTENANCE	20
EVERY THREE MONTHS	20
UPHOLSTERY MAINTENANCE AND STAIN REMOVAL	20
FOR GUARDIAN, PATRIOT PLUS, RENAISSANCE AND SAVOY FABRICS ONLY	20
COLOR TRANSFER	20
DISINFECTANTS	20
CDC RECOMMENDATIONS.....	21
DISPOSAL AND KEY TO SYMBOLS	23
DISPOSAL.....	23
KEY TO SYMBOLS.....	24
CE CERTIFICATION	24
TECHNICAL SPECIFICATIONS.....	25
LIMITED WARRANTY	26
INDEX	27

INTRODUCTION

This manual contains assembly, operation, and maintenance instructions for the Lumex Clinical Care Recliner Series FR587W (Models FR587W, FR587WH, and FR587WHO). Read the entire manual carefully before using your recliner, and refer to it during use if you have questions. If you have further questions, please call Graham-Field / Lumex Technical Support at 1.770.368.4700.

INTENDED USE

Lumex Clinical Care Recliners are intended to make the care, treatment and recovery of patients easier and more comfortable. Lumex Clinical Care Recliners are used in a wide range of healthcare applications including Dialysis, Oncology, Drug Delivery, Same Day Surgery and Post-Operative Recovery. Lumex Clinical Care Recliners are ideal for use in hospitals, clinics and rehabilitation centers.

Lumex Series FR587W supports patient weights up to 450 lb (204.1 kg), EVENLY DISTRIBUTED.

IMPORTANT SAFETY PRECAUTIONS—READ BEFORE USE

The safety statements presented in this chapter refer to the basic safety information that the Series FR587W user must pay attention to and abide by. There are additional safety statements in other chapters or sections, which may be the same as or similar to the following, or specific to the operations. Please note the following special statements, used throughout this manual, and their significance:

- ⚠ WARNING:** Indicates a potential hazard situation or unsafe practice that, if not avoided, could result in death or serious personal injury.
- ⚠ CAUTION:** Indicates a potential hazard or unsafe practice that, if not avoided, could result in minor or moderate personal injury.
- ▲ NOTICE:** Indicates a potential hazard or unsafe practice that, if not avoided, could result in product or property damage.

Info: Provides application recommendations or other useful information to ensure that you get the most from your product.

WARNINGS

- ⚠ WARNING:** Read this entire manual before assembly or operation.
- ⚠ WARNING:** Periodically inspect all parts and replace as needed.
- ⚠ WARNING:** Do not use near an open flame, as the chair could be a combustion source, resulting in fire, property damage, and severe physical injury.
- ⚠ WARNING:** Service and repair of the Lumex Series FR587W Deluxe Extra Wide Clinical Care Recliner must be performed by a Graham-Field authorized distributor. GF Health Products, Inc. is not responsible for any consequence resulting from any unauthorized service or repair.
- ⚠ WARNING:** The electronics and / or actuator contain no serviceable components. If service is required, the unit must be returned to the factory for repair. **DO NOT** attempt to open the electronics or actuator or obtain local service; this will void the warranty and may result in damage to the unit. Consult your Graham-Field authorized distributor for further information.

- ⚠ WARNING: This product has a maximum weight capacity of 450 lb (204.1 kg), EVENLY DISTRIBUTED.**
- ⚠ WARNING: Casters must be locked at all times, except during transport.**
- ⚠ WARNING: Unauthorized modification of your recliner or the use of non-Lumex replacement parts may change the structure of the recliner and could create a hazardous condition, which may result in serious injury and will void the warranty.**
- ⚠ WARNING: This product can expose you to chemicals including Di(2-ethylhexyl)phthalate (DEHP) which is known to the State of California to cause cancer and birth defects or other reproductive harm. For more information go to www.p65warnings.ca.gov/furniture.**
- ⚠ WARNING: GF Health Products, Inc. specifically disclaims responsibility for any bodily injury or property damage which may occur during any use which does not comply with federal, state or local laws or ordinances.**

ASSEMBLY

UNPACKING

1. Check for obvious damage to the carton or its contents. If damage is evident, please notify the carrier and your Graham-Field authorized distributor.
2. Remove all packaging materials from recliner base.

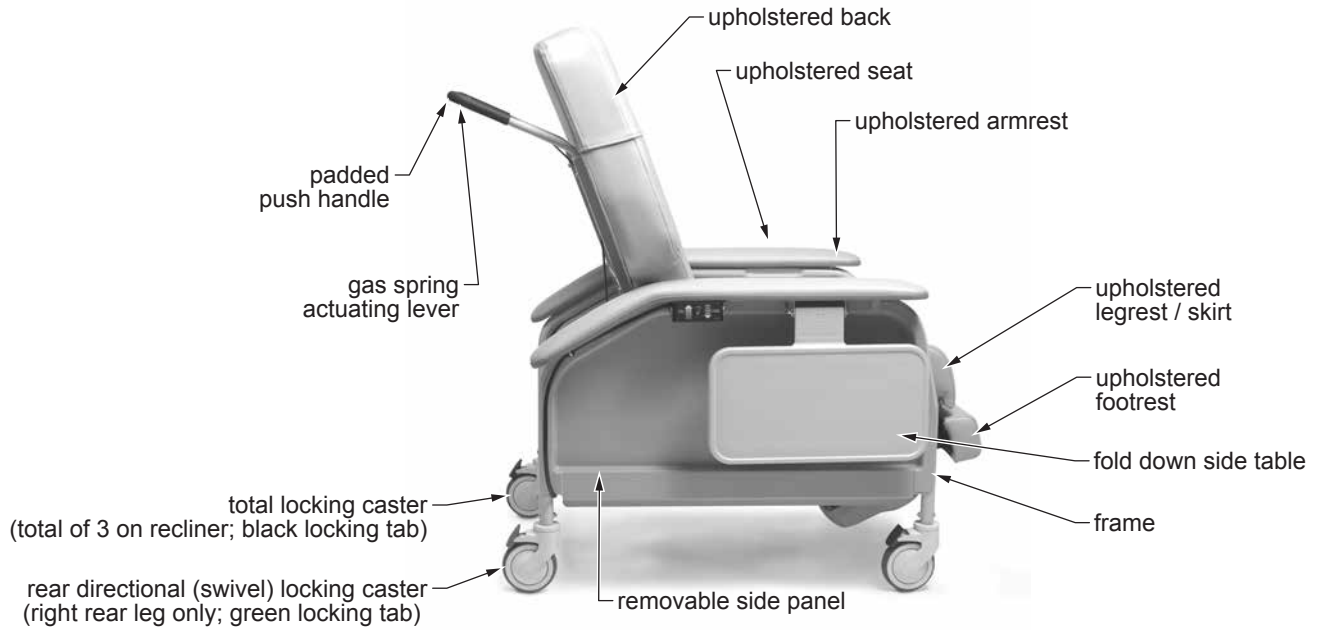

Clinical Care Recliner Series FR587W

Upholstered Back Assembly

1. After removing all components from the carton, engage all four locks on the casters before beginning assembly.
2. See the location of three clevis pins, two ring cotter pins and two large cotter pins at right.

Info: The center clevis pins are 5/16" in diameter. The outside clevis pins are 3/8" in diameter.

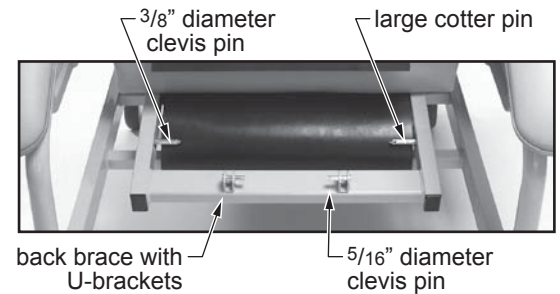

Back Assembly

- Remove cardboard shipping retainers and tape from around gas spring cylinders. Rotate the hinge section on the gas spring so that it is perpendicular to the upholstered back, as shown at right.

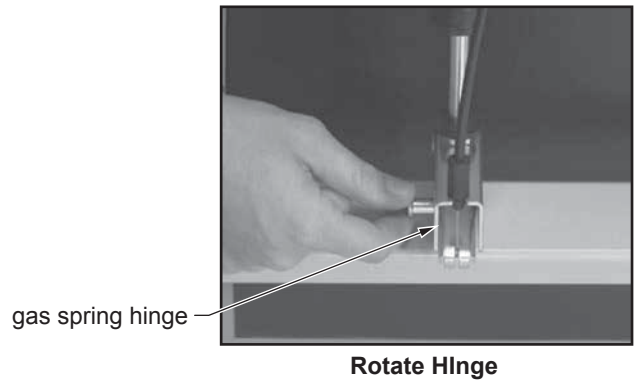

- Remove side panels from frame: Depress the two push buttons located on the lower sides of frame. Pull side panel gently away and down from frame. There are tabs on the frame underneath the armrest that hold the side panel in place.

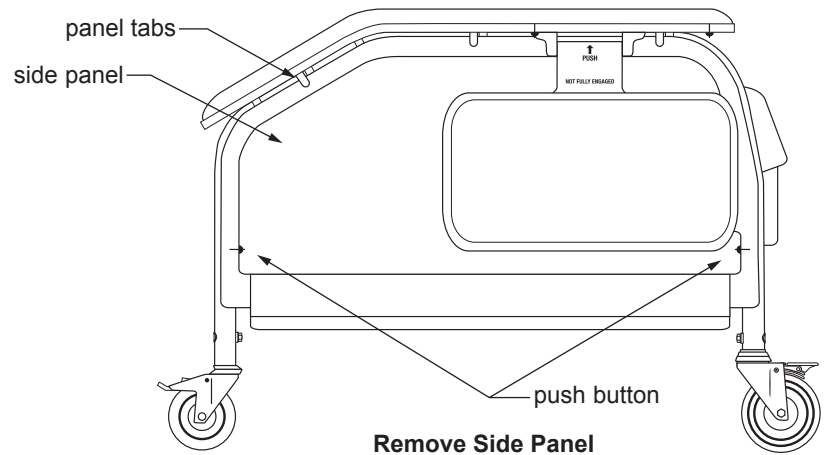

- Lift the upholstered back from the sides and place it horizontally with the upright back tubes resting on the recliner frame.

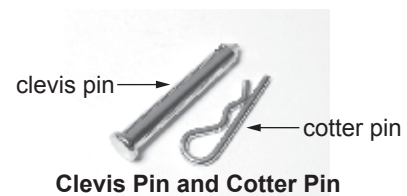

- Align the holes on the upright back tubes of the upholstered back with the holes on the seat frame. Place the $\frac{3}{8}$ " diameter clevis pins through the mounting holes in the frame and back as shown at right.

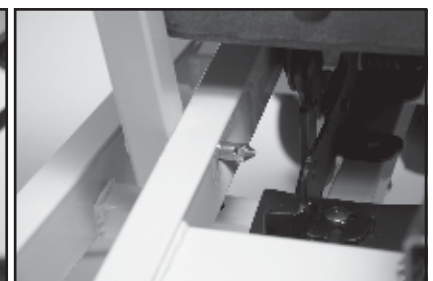

- Secure the two clevis pins by placing a large cotter pin through the hole in the clevis pin (one for each side) as shown at right.



8. Raise the upholstered back to vertical position. Tuck the plastic skirt at rear of upholstered back behind seat frame crossbrace. Align the hinges at the bottom of the gas springs with the holes in the U-brackets on the seat frame crossbrace. While holding the back in position with one hand, secure both gas spring hinges to the U-brackets by placing two $\frac{5}{16}$ " diameter clevis pins through the U-brackets and hinges with the other hand.

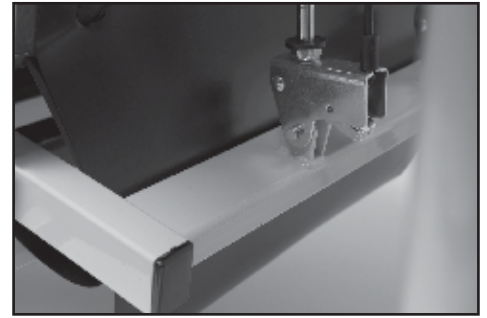

Place Clevis Pins

9. Secure the clevis pins by placing the ring cotter pins through the hole in the clevis pins as shown at right.



Place Cotter Pins

10. Replace side panels:
Insert side panel into recliner frame by locating the tabs underneath the armrest. Make sure side panel is properly aligned and that the top edge is behind the locking tabs. Press side panel into frame sides. Make sure that both push buttons are protruding into side panel to ensure side panel is locked in place.

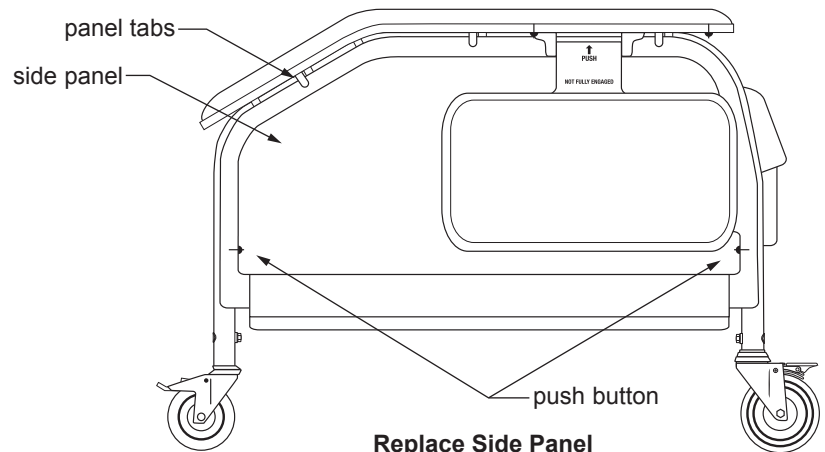

Replace Side Panel

OPERATION

⚠ **WARNING: Disconnection of the device:** In case of emergency, always disconnect the device by removing the power cord plug from the power outlet.

TENTE® CASTERS

⚠ **WARNING: Casters must be locked at all times, except during transport.**

All Lumex Clinical Care Recliners now feature the latest design, all-plastic casters from TENTE. Specifically designed for use in healthcare environments, the new casters are easier to clean, easier to move, and tolerate a wide array of cleaners and chemicals. Each caster is made from high-grade synthetic materials and features a double-ball bearing swivel head. The wheel center is made of polypropylene and the tire tread of TENTEprene (thermoplastic rubber). The gray non-marking tires feature precision ball bearings.

Locking casters: Each Lumex Clinical Care Recliner features three total locking casters, identified by black actuator tabs, that lock both the wheel and the swivel.

To activate the total lock, simply press down on the BLACK actuator tab until it locks. To release the total lock, press on the raised portion of the actuator tab until the lever is back in the normal operating position.

Directional (swivel) caster: The fourth caster, located on the right rear position of the recliner, is a directional (swivel) locking caster only. Identified by a green actuator tab, the directional lock caster will lock in one of two 180-degree positions relative to the frame (forward and backward) and allows the recliner to track straight when pushed. To activate the directional lock, simply press down on the GREEN actuator tab until it locks — you may need to move the recliner slightly until the caster locks in a straight line with the recliner frame. To release the directional lock, press on the raised portion of the actuator tab until the lever is back in the normal operating position.

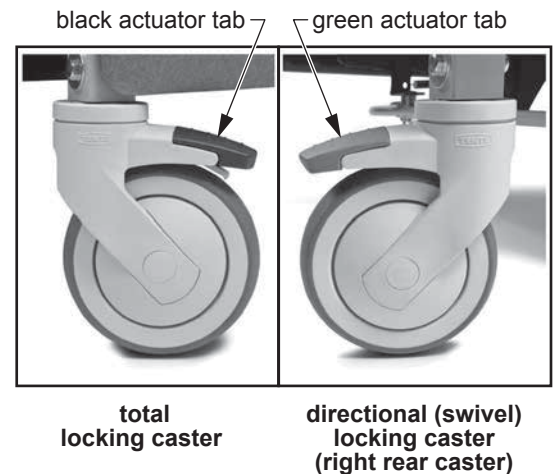

SIDE TABLE OPERATION

To raise table: Raise the side table all the way up and slide in toward the armrest until tabs engage slots in mount bracket. Press down lightly on table to ensure locking tabs are engaged.

To lower table: Lift the side table up slightly until tabs disengage slots and pull table away from armrest. Lower side table to self-storing position.

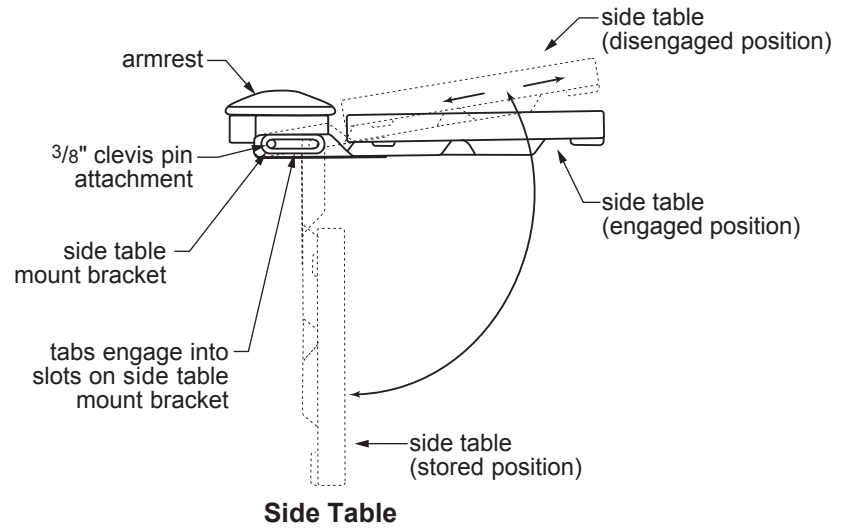

SIDE PANEL OPERATION

For easy cleaning and access to the side and underside of the recliner, Lumex Clinical Care Recliners feature easy-to-remove side panels.

To remove side panel:

Depress the two push buttons located on the lower sides of frame. Pull side panel gently away and down from frame. There are tabs on the frame underneath the armrest that hold the side panel in place.

To install side panel:

Insert side panel into recliner frame by locating the tabs underneath the armrest. Make sure side panel is properly aligned and that the top edge is behind the locking tabs. Press side panel into frame sides. Make sure that both push buttons are protruding into side panel to ensure side panel is locked into place.

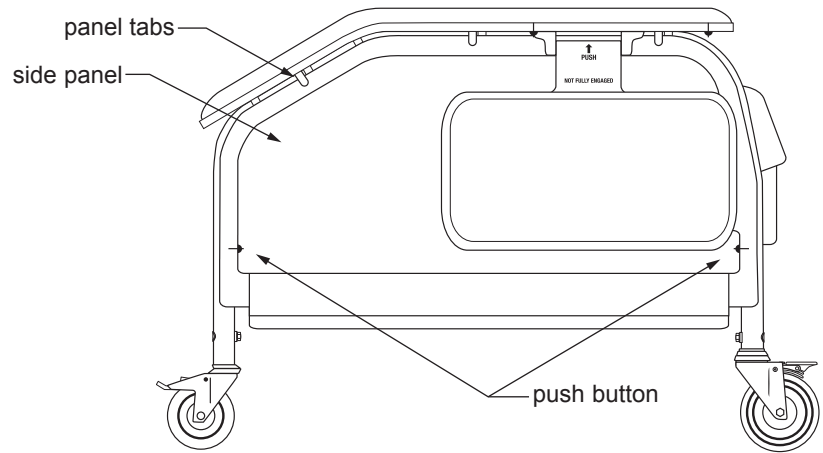

Removable Side Panel

RECLINER OPERATION

The Lumex Series FR587W Recliner features three positions for patient comfort. The fourth position is a Trendelenburg (or Shock Position) that must be activated by a caregiver. The Trendelenburg Position CANNOT be activated by a patient while in the recliner. In addition, the Series FR587W features a back that can be repositioned via the adjustment lever located on the push handle on the back of the recliner.

First Position (Upright Position)

The first position is the **Upright Position**. This position is ideal for patient transport and can be used to initiate patient treatment / therapy.

Second Position (First Recline Position)

The second position is the **First Recline Position** and is also known as the “TV” position. This position is ideal for patient treatment, rest and reading.

To Achieve Second Position / First Recline Position:

- Reclining by patient: Place hands on armrests and push body against recliner back to recline yourself to desired position. To bring yourself up, place hands on armrests and pull yourself up while leaning your body forward, away from the recliner back, while at the same time pushing down evenly on the footrest with your legs.
 - Reclining by attendant: Standing on either side of the recliner, grasp the armrest with one hand and the push handle with the other hand. Push back on push handle to recline. To return, grasp push handle and pull forward to raise the recliner’s back.
- ▲ **NOTICE: DO NOT use the footrest by itself to return the recliner to an upright position from any recline position. Doing so may damage the recliner mechanism. Please follow the instructions above to operate the recliner.**



Upright Position



First Recline Position
(TV Position)

Third Position (Second Recline Position)

The third position is the **Second Recline Position** and is also known as the “Full Recline” position. This position is ideal for patient treatment, rest and reading.

To Achieve Third Position / Second Recline Position:

- By the patient: From the First Recline Position, continue to push against the back by placing your hands on armrests and continue to recline yourself to the Second Recline Position. To bring yourself up, place hands on armrest and pull yourself up while leaning your body forward away from the recliner back while at the same time pushing down evenly on the footrest with your legs.
- Reclining by attendant: Standing on either side of the recliner, grasp the armrest with one hand and push handle with the other hand. Push back on push handle to recline. To return, grasp push handle and pull forward to raise the recliner back.



**Second Recline Position
(Full Recline Position)**

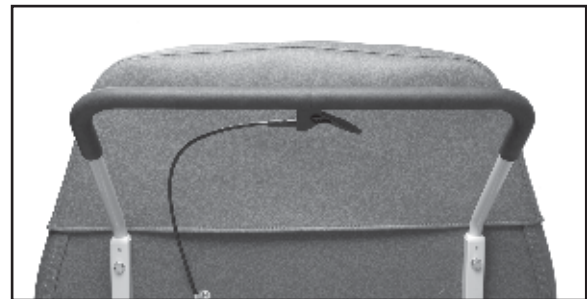

Lever

Info: Due to the 450 lb (204.1 kg) weight capacity, EVENLY DISTRIBUTED, the Series FR587W Recliner has two gas pistons to assist in the recline and return of the back. One piston assists during the rearward movement of the back, the other piston assists during the return of the back to an upright position. For this reason, in order for the gas piston to operate properly, a person of at least 150 lb (68.0 kg) should be sitting in the recliner.

Trendelenburg Position (Also Known as Shock Position)

Info: This position can only be achieved by a caregiver.

Standing at the back of the recliner, grasp the push handle with one hand while actuating the Lever located on the rear push handle with other. Slowly guide the back down fully until it stops and release the lever. If the articulating headrest is in the forward position, push back so that it is even with the back of the recliner.

Trendelenburg Position can be obtained from any position.

To bring recliner out of Trendelenburg, stand at the back of the recliner and actuate the lever shown in upper right picture. Slowly guide the back upright and release the lever. The recliner can then be placed in the desired position.



**Trendelenburg Position
(Shock Position)**

GAS SPRING TROUBLESHOOTING GUIDE

Info: gas springs have been pre-adjusted at factory

The gas spring on your recliner provides counterbalancing forces, and is self-locking for infinite, precise positioning. Unlocking the gas spring is controlled by actuating the lever located on the padded push handle on the back of the recliner. When the lever is actuated it pulls on the cable which in turn pulls on a hinge, depressing a button at the end of the gas spring rod. If the gas spring does not unlock when the lever is actuated or if it remains permanently unlocked when the lever is actuated, the cable must be adjusted.

Adjusting Cable Tension

1. Remove the one screw and cable clip which secure the cable to the upholstered back. Remove the gas spring from the recliner by disassembling the two ring cotter pins and the two clevis pins that secure the gas spring to the back / frame.
2. Lower the back until it rests on the stop bars on the recliner frame. Loosen the lock nut on the gas spring.
3. Hold the hinge assembly while turning the gas spring until the cable just becomes taut. Back off the gas spring an additional half turn.

Info: If the gas spring was not unlocking when the lever was actuated, the gas spring must be turned clockwise. If the gas spring was not locking when the lever was released, the gas spring must be turned counter-clockwise.

4. Retighten the lock nut.
5. Reassemble the gas spring to the back of the recliner by replacing the clevis pins, bridge pins, and re-attach cable to back of recliner with the screw and cable clip.
6. Actuate the recliner in accordance with the operating instructions to verify correct adjustment.



Adjusting Cable Tension 1

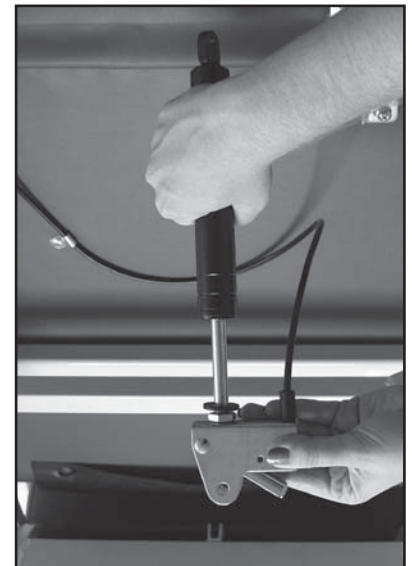

Adjusting Cable Tension 2

RECLINERS WITH HEAT AND MASSAGE OR HEAT ONLY FEATURE

HEAT AND MASSAGE: FR587WH

HEAT ONLY: FR587WHO

INSTALLATION AND OPERATING GUIDE

- ⚠ **WARNING:** Important! Read and understand these instructions before assembling or using the Lumex Specialty Healthcare Seating Heat and Massage / Heat Only Unit. If you do not understand any part of these warnings, cautions or instructions, contact a healthcare professional for direction in the use of this product. If the Heat and Massage / Heat Only Unit is not properly assembled, personal injury and damage to the Heat and Massage / Heat Only Unit could result.
- ⚠ **WARNING:** The recliner seat and back heating elements are wired to operate in series only. Do not change the system wiring in any way.
- ⚠ **WARNING:** If components are damaged or missing, contact your Graham-Field authorized distributor immediately. **DO NOT** use substitute parts. Use only Lumex replacement parts. The use of non-Lumex replacement parts could cause personal injury, property damage, and void the warranty.
- ⚠ **WARNING:** GF Health Products, Inc. assumes no responsibility for any damage or injury caused by improper assembly or use of this product.

Description

The Heat and Massage Unit offers three levels of seat and back heat, as well as a gentle or firm massage function for just the lower back or both lower and upper back; the Heat Only Unit offers three levels of seat and back heat. The Lumex Healthcare Seating Heat and Massage / Heat Only Unit is a low-voltage (12V) Heat and Massage / Heat Only Unit, controllable by the user and / or caregiver via a handheld pendant. It is designed to enhance the comfort of the patient / resident during the use of Lumex Clinical Care Recliners.

Connection

The Heat and Massage / Heat Only Unit comes pre-installed in Lumex Clinical Care Recliners with the Heat and Massage / Heat Only Option.

*Info: Model FR587WH (Heat and Massage) requires two connections; one for the control box and the other for the massage motor (see following **Heat and Massage / Heat only Installation Instructions**).*

*Info: Model FR587WHO (Heat Only) requires one connection for the control box (see following **Heat and Massage / Heat only Installation Instructions**).*

Main Components

1. All Heat and Massage / Heat Only functions are controlled by the handheld pendant.
2. The handheld pendant comes pre-installed and is wrapped to the bottom of the seat. To store the pendant when not in use or for caregiver use, place it in the pendant storage bracket mounted on the back of the recliner as shown at right.



Handheld Heat and Massage Pendant Shown in Storage Bracket on Back of Recliner

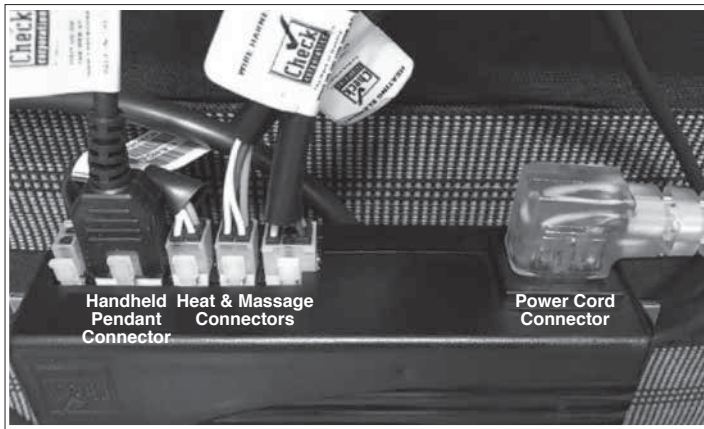

**Heat and Massage Feature —
Control Module and Transformer Unit
Showing All Connections Correctly Made**

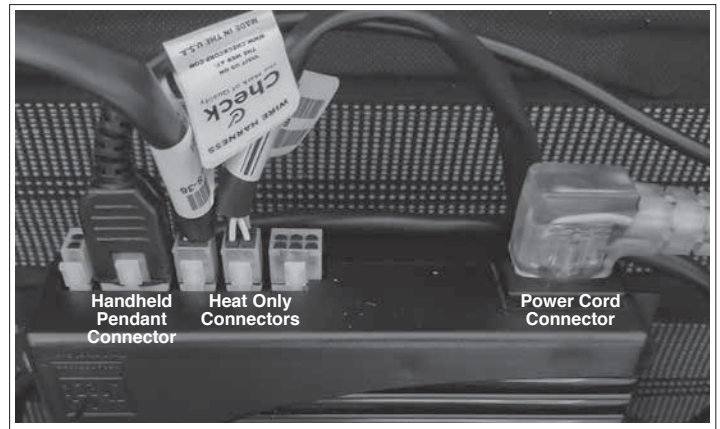

**Heat Only Feature —
Control Module and Transformer Unit
Showing All Connections Correctly Made**

2. The Control Module and Transformer, shown above, are contained in a single unit mounted in the back compartment. The 8-foot power cord plugs into the wall AC outlet.

Heat and Massage / Heat only Installation Instructions

During recliner shipment, the Heat and Massage / Heat Only cable connections are disconnected.

Info: Model FR587WH (Heat and Massage) requires two connections; one for the control box (the following step #4) and the other for the massage motor (the following steps #6 and 7).

Info: Model FR587WHO (Heat Only) requires one connection for the control box (the following step #4).

⚠ CAUTION: To prevent personal injury and damage to the recliner always obtain assistance when positioning the recliner as instructed in the following sections.

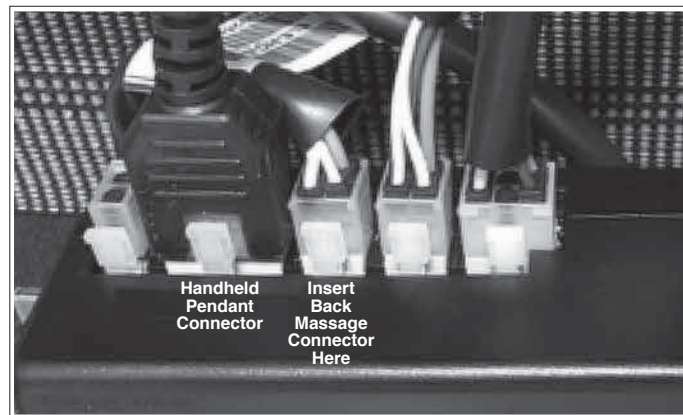

**Heat and Massage Feature —
Control Module and Transformer Unit
Showing All Connections Correctly Made**

1. Install the back assembly and gas spring on the seat frame with the clevis pins and clips supplied with the recliner as indicated in your recliner's Assembly and Operating Manual.

2. Remove the left side table, shown at right, from the recliner to prevent damage to it during setup: Withdraw the ball lock pin, shown at right, and set ball lock pin and table aside.
3. Place a protective cover or drop cloth on your workbench or floor to protect the recliner frame finish and upholstery. With assistance, carefully roll the recliner and rest it on its left side to provide access to the seat bottom, as shown at right. If desired, for better access, you may roll the recliner completely upside down. Carefully extend the footrest partway for access to the components, as shown at right.

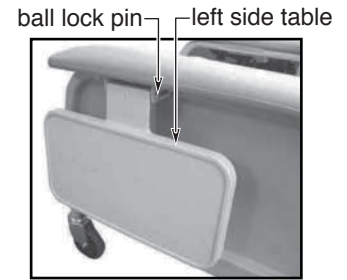

Remove Left Side Table

⚠ WARNING: DO NOT place your hands in the path of the moving recliner mechanism. Moving parts could cause personal injury.

4. For both Heat and Massage and Heat Only Functions: Insert the cable connector labeled BACK into the control module connector (see picture of control module on previous page) until its locking tab snaps into place.
5. **For Heat and Massage Functions only:** Locate the black plastic corrugated tube at the lower back of the Recliner.
6. **For Heat and Massage Functions only:** Pull on the red wires coming out of the plastic tube.



Roll Recliner onto its Left Side



Connect Massage Motor Wires



Insert Cable Connector Labeled SEAT Through Bushing

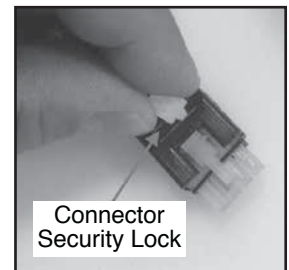

Connector Security Lock

7. **For Heat and Massage Functions only:** There is a connector within the plastic tube labeled “Massage Motors” — connect this connector to the other Massage Motor connector shown above.
8. If you need to replace the Handheld Pendant, remove the small white connector security lock as shown at right.
9. With assistance, carefully return the recliner to its upright position.
10. Reinstall the left side table with the ball lock pin.
11. The Heat and Massage / Heat Only Unit is now ready for operation. Instructions for use follow.

▲ NOTICE: Before rolling the recliner, ensure the power cord is unplugged from the AC outlet.

Heat and Massage / Heat Only Unit Operation Instructions

1. Plug the power cord into any grounded outlet.



Handheld Pendant
Heat and Massage



Handheld Pendant
Heat Only

2. The Heat and Massage / Heat Only Unit is operated using the Handheld Pendant, shown above.



Heat and Massage



Heat Only

3. **The Heat and Massage Pendant Selector Switch Faceplate**, shown at above left, has two membrane switches. The left switch controls the Massage Function and the right switch controls the Heat Function. You can use either the Heat or Massage or both functions at the same time.

The Heat Only Pendant Selector Switch Faceplate, shown at above right, has a single membrane switch to control the Heat Only Function.

4. **Heat and Massage *MASSAGE* Option:** Press the *MASSAGE* switch to start this function. The Massage Function Settings are as follows:
 - a) Press selector switch for Setting 1: Gentle Lower Back Massage.
 - b) Press selector switch AGAIN for Setting 2: Firm Lower Back Massage.
 - c) Press selector switch AGAIN for Setting 3: Gentle Upper and Lower Back Massage.
 - d) Press selector switch AGAIN for Setting 4: Firm Upper and Lower Back Massage.
 - e) Press selector switch AGAIN: Massage function Shuts Off.
5. **Heat and Massage or Heat Only *HEAT* Option:** Press the *HEAT* switch to start this function. The Heat Function Settings are as follows:
 - a) Press selector switch for Setting 1: High Heat, 104°F (40°C), brightest LED.
 - b) Press selector switch AGAIN for Setting 2: Medium Heat, 101°F (38.6°C), bright LED.
 - c) Press selector switch AGAIN for Setting 3: Low Heat, 100°F (37.8°C), dim LED.
 - d) Press selector switch AGAIN: Heat function shuts off.
 - e) There is a small red indicator light, which illuminates only during the Heat function, in the selector switch. The light's brightness is determined by the Heat level being used:
Brightest = High Heat; Dimmest = Low Heat.
6. The Unit automatically shuts off at the following times:
 - a) **HEAT FUNCTION:** After one hour of continuous use at the same level.
 - b) **MASSAGE FUNCTION:** After fifteen minutes of continuous use at the same level.
 - c) To restart the Unit, follow previous steps 4 and 5.

Heat and Massage / Heat Only Unit Troubleshooting Guide

The cables and connections need to be validated. This will require the services of a maintenance person and a clear working area.

1. **INSPECTION:** Perform the following checks. If a working recliner of the same model is available, use it for comparison.

- a) Is the AC cord properly connected to the power supply? Is the cable from the power supply to the control module junction box in place?
- b) With the power supply AC cord plugged into a live AC outlet, does the small light to the left of the white seat symbol (located on the switch) light up when the switch is pressed repeatedly or is there any indication of massage operation?

⚠ WARNING: Disconnect the power cord from the AC outlet before performing the following steps!

- c) Is there any sign of external damage to the handheld pendant or wire?
- d) Is there any sign of external damage to the recliner?
- e) Do any of the cables show any sign of damage or pinch points?
- f) Are all cable connections to the control module in place? Are the connectors fully engaged?
- g) Are any of the connectors damaged?
- h) Are the wires within the connectors attached to the pins? Each wire may have to be tugged lightly to check if the wire is still crimped to the pin.

2. **POST-INSPECTION:**

- a) If improper or loose connections are found, reconnect them firmly (unless a loose wire has been found). Plug the power supply AC cord into a live wall socket and operate the unit through all functions.
- b) If the handheld pendant or wire is damaged, notify Graham-Field so that a handheld pendant can be sent for replacement.
- c) If damage to any other electrical cable or component, or disconnected wires are found, please notify Graham-Field.

3. **ACTIONS:**

- a) If full operation is restored, please advise Graham-Field of your successful outcome.
- b) If the fault cannot be corrected by simple re-connection, please inform Graham-Field of the results of your inspection in detail so that we may determine the appropriate action to be taken.

If you have any questions about the setup and / or operation of the Heat and Massage / Heat Only Unit, call the Graham-Field Technical Support Group at 1.770.368.4700.

CARE AND MAINTENANCE

⚠ WARNING: Inspect all components periodically and replace as needed.

EVERY THREE MONTHS

- Check and clean casters.
- Tighten bolts in each leg that secure caster into frame.
- Check caster brakes.
- Check and clean lock recline mechanism.
- Check recliner mechanism for operation in all positions, including Trendelenburg Position, with assistant seated in recliner.

UPHOLSTERY MAINTENANCE AND STAIN REMOVAL

We recommend cleaning at least once a week to extend the lifespan of the upholstery. This prevents dirt and other contaminants from building up and stains from becoming permanent. If there is a spill, wipe off any excess right away with a dry cloth, making sure not to spread it all over the surface.

- Clean the whole surface in circular motions using liquid hand soap (pH neutral) and water (1 part soap to 9 parts water). Wipe with a clean damp cloth to get rid of any excess soap.
- Repeat as needed and then let dry.

For Guardian, Patriot Plus, Renaissance and Savoy fabrics only

If there is any build-up that can't be removed with soapy water, then use this as a last resort. Mixture: 1 part isopropyl alcohol to 1 part water.

Info: Using alcohol on a regular basis can affect the properties of the product.

- Once a month, you can use a soft-bristle brush for a deeper cleaning.

Info: Light colors need more care, more often.

Info: The cleaning products recommended were used in a laboratory setting. Spradling Group® has no relationship with the manufacturers of those cleaning products.

Color Transfer

Certain clothing and accessory dyes (such as those used on denim jeans) may migrate to lighter colors. This phenomenon is increased by humidity and temperature and is irreversible.

Check compatibility when using this product in combination with painted or varnished surfaces.

Disinfectants

In addition to cleaning, healthcare facilities maintain disinfecting regimens to reduce the spread of infections. There is a wide variety of available biocides that include bleaches, peroxides and quaternary ammonium products, among others. They should always be used at the recommended dilution, never in concentrated form. To prolong the life of coated fabrics, the disinfectants should be rinsed off after each use.

Info: Misuse of disinfectants is the major source of surface deterioration. Spradling International, Inc.® continually evaluates cleaners/disinfectants, and a list of those tested can be found on their website.

Abrasion test results exceeding ACT Performance Guidelines are not an indicator of product lifespan. Multiple factors affect fabric durability and appearance retention.

This information is not a guarantee and does not relieve the user from the responsibility of the proper and safe use of the product and all cleaning agents. The use of certain agents can be harmful to the surface appearance and lifespan of vinyl. Spradling, its agents, and assignees assume no responsibility resulting from the use of such cleaning agents to the vinyl.

Check compatibility when using this product in combination with painted or varnished surfaces.

Spradling Group® and Spradling International, Inc.® are registered trademarks of Spradling Holdings, Inc.

CDC RECOMMENDATIONS

CLEANING AND DISINFECTING STRATEGIES FOR ENVIRONMENTAL SURFACES IN PATIENT-CARE AREAS FOR VINYL UPHOLSTERY, WALL COVERINGS AND FLOORING

- Select EPA-registered disinfectants, if available, and use them in accordance with the manufacturer's instructions.
- Do not use high-level disinfectants / liquid chemical sterilants for disinfection of either noncritical instruments and devices or any environmental surfaces; such use is counter to label instructions for these toxic chemicals.
- Follow manufacturers' instructions for cleaning and maintaining noncritical medical equipment.
- In the absence of a manufacturer's cleaning instructions, follow certain procedures:
 - Clean noncritical medical equipment surfaces with a detergent / disinfectant.
 - Do not use alcohol to disinfect large environmental surfaces.
 - Use barrier protective coverings as appropriate for noncritical surfaces that are:
 - Touched frequently with gloved hands during the delivery of patient care.
 - Likely to become contaminated with blood or body substances.
 - Difficult to clean (e.g., computer keyboards).
- Keep housekeeping surfaces (e.g., floors, walls, tabletops) visibly clean on a regular basis and clean up spills promptly.
- Use a one-step process and an EPA-registered hospital detergent / disinfectant designed for general housekeeping purposes in patient-care areas where:
 - Uncertainty exists as to the nature of the soil on the surfaces (whether it is blood or body fluid or just normal dust or dirt).
 - Uncertainty exists regarding the presence of multi drug resistant organisms on such surfaces.
- Detergent and water are adequate for cleaning surfaces in nonpatient-care areas (e.g., administrative offices). Clean and disinfect high-touch surfaces on a more frequent schedule than minimal-touch housekeeping surfaces. Clean walls, blinds, and window curtains in patient-care areas when they are visibly dusty or soiled.
- Do not perform disinfectant fogging in patient-care areas.
- Avoid large-surface cleaning methods that produce mists or aerosols, or disperse dust in patient-care areas.

- Follow proper procedures for effective uses of mops, cloths, and solutions.
 - Prepare cleaning solutions daily or as needed, and replace with fresh solution frequently according to facility policies and procedures.
 - Change the mop head at the beginning of each day and also as required by facility policy, or after cleaning up large spills of blood or other body substances.
 - Clean mops and cloths after use and allow to dry before reuse; or use single-use, disposable mop heads and cloths.
- When performing low- or intermediate-level disinfection of environmental surfaces in nurseries and neonatal units, avoid unnecessary exposure of neonates to disinfectant residues on these surfaces by using EPA-registered germicides in accordance with manufacturers' instructions and safety advisories.

DISPOSAL AND KEY TO SYMBOLS

DISPOSAL

Lumex Recliner equipment and accessories can be disposed of.







We recommend disassembling and dividing the equipment and components into different waste groups such as: metal, cable, electronic, recoverable resource and plastic for recycling or combustion.





Most plastic components are provided with a plastic types code and fiber content to aid sorting of plastic parts.

Product	Metal Scrap	Cable Scrap	Electronic Scrap	Plastic Recycling or Combustion
FR587W	X	X	N/A	X
FR587WH	X	X	X	X
FR587WHO	X	X	X	X

KEY TO SYMBOLS

The following symbols are used on Lumex Recliner product labels.

	MANUFACTURER
	FRAGILE, HANDLE WITH CARE
	CE MARK
	CAUTION
	EUROPEAN AUTHORIZED REPRESENTATIVE
	UNIQUE DEVICE IDENTIFIER

	GENERAL WARNING SIGN
	KEEP DRY
	ELECTRICAL AND ELECTRONIC EQUIPMENT
	CONSULT INSTRUCTIONS FOR USE
	MEDICAL DEVICE

CE CERTIFICATION (SERIES FR587W ONLY)

Info: CE Certification applies ONLY to Series FR587W Deluxe Clinical Care Recliner, Extra Wide.

CE Certification DOES NOT apply to Deluxe Clinical Care Recliners, Extra Wide with Heat and Massage (Series FR587WH) or Deluxe Clinical Care Recliners, Extra Wide with Heat Only (Series FR587WHO).



GF Health Products, Inc.

One Graham-Field Way, Atlanta, Georgia 30340-3140

Tel: 1.770.368.4700 Web: www.grahamfield.com

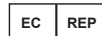

EC Authorized Representative
CEpartner4U BV, ESDOORNLAAN 13
3951 DB MAARN The Netherlands
+31 (0)6 516.536.26
www.cepartner4u.com



TECHNICAL SPECIFICATIONS

Specification	Series FR587W / FR587WH / FR587WHO
Overall Height	50" (129.5 cm)
Overall Width	33" (83.8 cm)
Overall Depth	36" (91.4 cm)
Width Between Arms	23" (58.4 cm)
Arm Height from Floor	26 1/2" (67.3 cm)
Arm Height from Seat	8" (20.3 cm)
Seat Height	21 1/2" (54.6 cm)
Seat Width	23 1/2" (59.7 cm)
Seat Depth	20 1/2" (52.1 cm)
Depth Fully Reclined in Trendelenburg	76" (193.0)
Width with Both Side Tables in Upright Position	53" (134.6 kg)
Shipping Weight	138 1/2 lb (62.8 kg)
Maximum Weight Capacity	450 lb (204.1 kg), EVENLY DISTRIBUTED

For complete technical specifications, please call the Graham-Field Technical Support Group at 1.770.368.4700.

LIMITED WARRANTY

SCOPE OF WARRANTY

GF Health Products, Inc. (GF) warrants to the original purchaser only that it will replace or repair components, at GF's sole discretion, that are defective in material or workmanship under normal use and service. All warranties are conditioned upon the proper use of the products strictly in accordance with good commercial practice and applicable GF instructions and manuals, including proper use and maintenance. To the extent that a component is warranted by a third party, GF conveys all of its rights under that warranty to the original purchaser, to the extent permitted.

This limited warranty shall only apply to defects that are reported to the appropriate party listed in the **OBTAINING WARRANTY SERVICE** section that follows, within the applicable warranty period and which, upon examination by GF or its authorized representative, prove to be a warranty item. This limited warranty is not transferable.

Within the guidelines set forth in this document, the following components are warranted for the time period set forth below:

Steel Frame:.....Ten Years
Mechanical Components:.....Three Years
Heat and Massage Unit:Two Years
Heat Only Unit:Two Years
Casters:.....One Year
Upholstered Components:One Year
Replacement Parts:Ninety Days

* Labor is not included in the warranty.

† Upholstery is only warranted on material supplied by GF.

‡ The warranty period is as designated above. If a part is replaced under warranty, the original warranty period will not be affected. All other replacement parts will be subject to the warranty period specified.

The applicable warranty period shall commence from date of shipment to the original customer, unless there is an expiration date on the component in which case the warranty shall expire on the earlier of warranty period or the expiration date.

OBTAINING WARRANTY SERVICE

Customers located in the United States who wish to report a warranty issue, must contact GF directly by calling 1.770.368.4700 or by e-mailing a request to cs@grahamfield.com.

Customers located outside the United States who wish to report a warranty issue, must contact the Distributor from whom they purchased the products.

In both cases, further directions will be provided once the initial contact is made. This limited warranty shall only apply to defects that are reported within the applicable warranty period. Failure to abide by the specific directions will result in denial of the warranty claim.

EXCLUSIONS

The warranty does not cover and GF shall not be liable for the following:

1. Defects, damage, or other conditions caused, in whole or in part, by misuse, abuse, negligence, alteration, accident, freight damage, tampering or failure to seek and obtain repair or replacement in a timely manner;
2. Products which are not installed, used, or properly cleaned and maintained as required in the official manual for the applicable product;
3. Products considered to be of a non-durable nature including, but not limited to: filters, fuses, gaskets, lubricants, and charts;
4. Accessories or parts not provided by GF;
5. Matching of color, grain or texture except to commercially acceptable standards;
6. Changes in color caused by natural or artificial light;
7. Charges by anyone for adjustments, repairs, replacement parts, installation or other work performed upon or in connection with such products which are not expressly authorized in writing, in advance, by GF;
8. Any labor or shipping charges incurred in the replacement part installation or repair;
9. Costs and expenses of regular maintenance and cleaning; and
10. Representations and warranties made by any person or entity other than GF.

ENTIRE WARRANTY, EXCLUSIVE REMEDY AND CONSEQUENTIAL DAMAGES DISCLAIMER

THIS WARRANTY IS GF'S ONLY WARRANTY AND IS IN LIEU OF ALL OTHER WARRANTIES, EXPRESS OR IMPLIED. GF MAKES NO IMPLIED WARRANTIES OF ANY KIND INCLUDING ANY IMPLIED WARRANTIES OF MERCHANTABILITY OR FITNESS FOR A PARTICULAR PURPOSE. IF ANY MODEL OR SAMPLE WAS SHOWN TO THE CUSTOMER, SUCH MODEL OR SAMPLE WAS USED MERELY TO ILLUSTRATE THE GENERAL TYPE AND QUALITY OF THE PRODUCT AND NOT TO REPRESENT THAT THE PRODUCT WOULD NECESSARILY CONFORM TO THE MODEL OR SAMPLE IN ALL RESPECTS. THIS WARRANTY IS LIMITED TO THE REPAIR OR REPLACEMENT OF THE DEFECTIVE PARTS. GF SHALL NOT BE LIABLE FOR AND HEREBY DISCLAIMS ANY DIRECT, SPECIAL, INDIRECT, INCIDENTAL, EXEMPLARY OR CONSEQUENTIAL DAMAGES, INCLUDING, BUT NOT LIMITED TO: DAMAGES FOR LOSS OF PROFITS OR INCOME, LOSS OF USE, DOWNTIME, COVER, OR EMPLOYEE OR INDEPENDENT CONTRACTOR WAGES, PAYMENTS AND BENEFITS. CERTAIN STATES MAY CONFER ADDITIONAL RIGHTS REGARDING WARRANTIES AND IN THOSE STATES GF'S LIABILITY AND THE LIABILITY OF GF'S SUPPLIERS, SHALL BE LIMITED TO THE FULLEST EXTENT PERMITTED BY LAW.

The warranties contained herein, together with GF's current Terms and Conditions, contain all the representations and warranties with respect to the subject matter of this document, and supersede all prior negotiations, agreements and understandings with respect thereto. The recipient of this document hereby acknowledges and represents that it has not relied on any representation, assertion, guarantee, warranty, collateral contract or other assurance, except those set out in this document.

For additional information on this product or this warranty, please contact a GF Customer Service Representative.

NOTES:

- 1) Additional terms and conditions may apply. See GF's General Terms and Conditions on its website: www.grahamfield.com.
- 2) Freight claims must be notated on the appropriate shipping documents and must be made with immediacy. International, federal and state regulations govern specific requirements for freight claims. Failure to abide by those regulations may result in a denial of the freight claim. GF will assist you in filing the freight claim.
- 3) Claims for any short shipment must be made within three (3) days of the invoice date.

INDEX

A

Assembly 5

C

Cable tension, adjusting 13

Care and maintenance 20

Caster, directional (swivel) 8

Caster, locking 8

Caster operation 8

CE Certification 24

D

Disposal 23

G

Gas spring troubleshooting guide 13

H

Heat and massage / heat only components 14

Heat and massage / heat only connections 14

Heat and massage / heat only description 14

Heat and massage / heat only feature 14

Heat and massage / heat only, installation and operating guide 14

Heat and massage / Heat only operation 17

Heat and massage / heat only troubleshooting guide 19

I

Important safety precautions 3

Intended use 3

Introduction 3

K

Key to symbols 24

L

Limited warranty 26

O

Operation 8

R

Recliner operation 11

S

Side panel, install 10

Side panel operation 10

Side panel, remove 10

Side table, lower 9

Side table operation 9

Side table, raise 9

Symbol key 24

T

Technical specifications 25

Trendelenburg (shock) position 12

U

Unpacking 5

Upholstered back assembly 5

Upholstery maintenance and stain removal 20

Upholstery maintenance: CDC recommendations 21

Upholstery maintenance: disinfectants 20

Upholstery maintenance for Guardian, Patriot Plus, Renaissance and Savoy fabrics 20

W

WARNINGS 3

Warranty, limited 26

LUMEX[®]

by graham-field

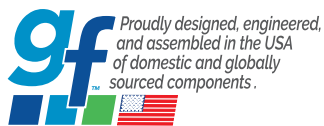

Manufactured By:
GF Health Products, Inc.
One Graham-Field Way, Atlanta, GA 30340

+1 770.368.4700
Information contained herein is subject to change without notice.
The most current and complete product information can be found on our website.
www.grahamfield.com

